

# Renishaw CMM products switch setting and connector guide

© 2005 - 2006 Renishaw plc. All rights reserved.

This document may not be copied or reproduced in whole or in part, or transferred to any other media or language, by any means, without the prior written permission of Renishaw.

The publication of material within this document does not imply freedom from the patent rights of Renishaw plc.

### **Disclaimer**

Considerable effort has been made to ensure that the contents of this document are free from inaccuracies and omissions. However, Renishaw makes no warranties with respect to the contents of this document and specifically disclaims any implied warranties. Renishaw reserves the right to make changes to this document and to the product described herein without obligation to notify any person of such changes.

### **Trademarks**

**RENISHAW®** and the probe emblem used in the RENISHAW logo are registered trademarks of Renishaw plc in the UK and other countries.

**apply innovation** is a trademark of Renishaw plc.

All other brand names and product names used in this document are trade names, service marks, trademarks, or registered trademarks of their respective owners.

**Renishaw CMM products  
switch setting and connector guide**



## **GB - Warnings**

In all applications involving the use of machine tools or CMMs, eye protection is recommended.

There are normally no user-serviceable parts inside Renishaw mains-powered units. Return defective units to an authorised Renishaw customer service centre.

Replace blown fuses with new components of the same type. Refer to the safety information in the relevant product documentation.

For instructions regarding the safe cleaning of Renishaw products, refer to the maintenance information in the relevant product documentation.

Remove power before performing any maintenance operations.

Always allow sufficient time for electrical charge to dissipate from electrical components before handling.

Observe anti-static handling precautions, including the use of earth straps with plug-in cards.

Refer to the machine supplier's operating instructions.

It is the machine supplier's responsibility to ensure that the user is made aware of any hazards involved in operation, including those mentioned in Renishaw product documentation, and to ensure that adequate guards and safety interlocks are provided.

Under certain circumstances the probe signal may falsely indicate a probe-seated condition. Do not rely on probe signals to stop machine movement.

The expected method of providing an emergency stop for Renishaw products is to remove power.

## **Care of equipment**

Renishaw probes and associated systems are precision tools used for obtaining precise measurements and must therefore be treated with care.

---

## Contents

1	Introduction.....	11
1.1	Renishaw CMM product support.....	11
2	PI 4 probe interface .....	12
2.1	Description .....	12
2.2	PI 4 probe interface switches .....	12
2.2.1	SW1 switches .....	12
2.2.2	SW2 switches .....	12
2.3	PI 4 probe interface connectors .....	13
2.3.1	Probe input .....	13
2.3.2	Remote HC1 input .....	13
2.3.3	OCT (open collector transistor) output.....	14
2.3.4	TTL (transistor transistor logic) output .....	14
2.3.5	SSR (solid state relay) output .....	15
3	PI 9 probe interface .....	16
3.1	Description .....	16
3.2	PI 9 probe interface connectors .....	16
3.2.1	Input signals.....	16
3.2.2	OCT, TTL and SSR output .....	16
3.2.3	Remote HC1 input .....	17
4	PI 4-2 probe interface .....	18
4.1	Description .....	18
4.2	PI 4-2 interface switches .....	18
4.3	PI 4-2 probe interface connectors .....	19
4.3.1	PICS input.....	19
4.3.2	PICS output .....	19
4.3.3	SSR output .....	20
5	PI 6 probe interface .....	21
5.1	Description .....	21
5.2	PI 6 probe interface connections.....	21
5.2.1	CMM signal.....	21
5.2.2	Probe signal.....	21
5.3	PI 6 specifications .....	22
5.3.1	Environmental specification .....	22
5.3.2	Screening.....	22
5.3.3	Electrical specification .....	22
5.3.4	PI 6 signal outputs .....	22
6	PI 12 probe interface .....	23

6.1	Description .....	23
6.2	PI 12 probe interface switches .....	23
6.3	PI 12 probe interface connectors .....	24
6.3.1	PICS input.....	24
6.3.2	PICS output.....	24
6.3.3	SSR output.....	25
7	PI 200 probe interface, version 4 to version 8 .....	26
7.1	Description .....	26
7.2	PI 200 probe interface version 4 to version 8 switches .....	27
7.3	PI 200 probe interface, version 9 and later .....	28
7.3.1	Description .....	28
7.4	PI 200 version 9 and later interface switches.....	28
7.5	PI 200 probe interface connectors, all versions .....	30
7.5.1	PICS input.....	30
7.5.2	PICS output.....	30
7.5.3	SSR output.....	31
7.5.4	SCR200 rack.....	31
8	VPI 1 video probe interface .....	32
8.1	Description .....	32
8.2	VPI 1 video probe interface switches .....	32
8.3	VPI 1 video probe interface connectors .....	32
8.3.1	75 Ohm co-axial output connector .....	32
8.3.2	Video probe input connector .....	33
8.3.3	Manual head input connector.....	33
8.3.4	PICS input.....	34
8.3.5	PICS output.....	34
8.3.6	Manual control and HC1 switch .....	35
8.3.7	SSR output.....	35
9	VPI 2 video probe interface .....	36
9.1	Description .....	36
9.2	VPI 2 video probe interface SW1 switches .....	36
9.3	VPI 2 video probe interface SW2 switches .....	37
9.4	VPI 2 video probe interface connectors .....	37

---

9.4.1	75 Ohm co-axial output connector .....	37
9.4.2	Video probe input connector .....	38
9.4.3	Manual head input connector .....	38
9.4.4	PICS input.....	39
9.4.5	PICS output .....	39
9.4.6	Manual control and HC1 switch .....	40
9.4.7	SSR output .....	40
10	OPI 6 probe interface .....	41
10.1	Description .....	41
10.2	OPI 6 probe interface, pre-version 4 switches .....	41
10.3	OPI 6 probe interface, post-version 4 switches.....	42
10.3.1	Description.....	42
10.4	OPI 6 probe interface, post-version 4 switches.....	42
10.5	OPI 6 probe interface connectors, all versions .....	43
10.5.1	PICS input.....	43
10.5.2	PICS output .....	43
10.5.3	CMM input/output connector.....	44
10.5.4	Probe head input connector.....	44
10.5.5	Interface output connector .....	45
11	PI 7 probe interface .....	46
11.1	Description .....	46
11.2	PI 7 probe interface switches .....	46
11.3	PI 7 interface connections .....	47
11.3.1	PICS input.....	47
11.3.2	PICS output .....	47
11.3.3	Probe input .....	48
11.3.4	SSR output .....	48
12	PD1 and PD7 interface modules .....	49
12.1	Description .....	49
13	PI 7-2 probe interface, pre-version 13.....	50
13.1	Description .....	50
13.2	PI 7-2 probe interface, version 13 and later. ....	51
13.3	Description .....	51
13.4	PI 7-2 probe interface connections, all versions .....	52
13.4.1	PICS input.....	52
13.4.2	PICS output .....	52
13.4.3	Probe input .....	53
13.4.4	SSR output .....	53
14	PI 7c and PI 7H version probe interfaces .....	54

14.1	Description .....	54
14.2	PI 7c and PI 7H version probe interface switches.....	54
15	AC1 and AC2 counter cards .....	55
15.1	AC1 counter card .....	55
15.1.1	Description .....	55
15.1.2	AC1 card switches .....	55
15.2	AC2 counter card .....	56
15.2.1	Description .....	56
15.2.2	AC2 counter card SW1 switches .....	56
15.2.3	AC2 counter card SW2 switches .....	57
15.3	AC1 and AC2 counter card connectors.....	58
15.3.1	SP600 multiwire probe signal input.....	58
15.3.2	PICS signal input .....	59
16	AC3 counter card.....	60
16.1	Description .....	60
16.2	AC3 counter card SW1 switches.....	60
16.3	AC3 counter card SW2 switches.....	61
16.4	AC3 counter card connectors.....	62
16.4.1	SP25M multiwire probe signal input.....	62
16.4.2	PICS signal input .....	63
17	PI 800 probe interface .....	64
17.1	Description .....	64
17.2	PI 800 probe interface switches .....	64
17.3	PI 800 probe interface, initial integration .....	65
17.3.1	PICS signal output .....	65
17.3.2	Additional signal output.....	65
17.4	PI 800 probe interface, AFTER initial integration .....	66
17.4.1	PICS signal output .....	66
17.4.2	Additional signal output.....	66
17.4.3	Remaining operating signal terminations after initial setup.....	67
17.4.4	PPOFF shock control.....	67
18	PI 800-2 probe interface .....	68
18.1	Description .....	68
18.2	PI 800-2 probe interface switches.....	68
18.3	PI 800-2 probe interface, initial integration.....	69
18.3.1	PICS signal output .....	69
18.3.2	Additional signal output.....	69
18.4	PI 800-2 probe interface, AFTER initial integration.....	70



18.4.1	PICS signal output.....	70
18.4.2	Additional signal output.....	70
18.4.3	Remaining operating signal terminations AFTER initial integration.....	71
18.4.4	PPOFF shock control.....	71
19	IS 1 interface selector.....	72
19.1	Description.....	72
19.2	IS 1 program modules and outputs.....	72
19.3	IS 1 connectors.....	73
19.3.1	IS 1 power input.....	73
19.3.2	IS 1 probe input.....	73
19.3.3	IS 1 channel output.....	73
19.3.4	IS 1 PICS output signal.....	74
19.3.5	IS1 channel output indicator.....	74
20	IS1-2 interface selector.....	75
20.1	Description.....	75
20.2	IS 1-2 channel outputs.....	75
20.3	IS 1-2 connectors.....	76
20.3.1	IS 1-2 probe input.....	76
20.3.2	IS1-2 channel output.....	76
20.3.3	IS1-2 PICS output signal.....	77
20.3.4	IS1-2 channel output indicator.....	77
20.4	IS1-2 installation rules.....	78
20.5	IS1-2 programming modules.....	78
21	MIH-SI serial interface.....	79
21.1	Description.....	79
21.2	MIH-SI switches.....	79
21.2.1	MIH-SI switches.....	79
21.3	MIH-SI connectors.....	80
21.3.1	Inlet power.....	80
21.3.2	MIH-SI RS232 communication.....	80
21.3.3	MIH-SI probe head connector.....	80
21.3.4	MIH-SI probe interface connector.....	81
22	IU80 interpolator unit for SP80.....	82
22.1	Description.....	82
22.2	IU80 switches.....	82
22.2.1	IU80 reset switch.....	82
22.3	IU80 connectors.....	82

---

	22.3.1	IU80 probe input .....	82
	22.3.2	IU80 signal output and CC6 card input .....	83
	22.4	Connecting IU80 to an OEM card .....	84
23		PHC9 Mk2 controllers.....	85
	23.1	Description .....	85
	23.2	PHC9 Mk RS232 version controller switches.....	85
	23.3	PHC9 Mk2 IEEE-488 version controller switches .....	86
	23.4	PHC9 Mk2 controller connectors.....	87
	23.4.1	Probe interface output.....	87
	23.4.2	PHD9 hand controller.....	87
	23.4.3	RS232 communication connector.....	88
	23.4.4	IEEE-488 communication connector.....	88
	23.4.5	Probe head connector.....	89
24		PHC9 controllers .....	90
	24.1	Description .....	90
	24.2	PHC9 communication switches.....	90
	24.2.1	RS232 communication.....	90
	24.2.2	IEEE communication.....	91
	24.3	PHC9 controller connectors .....	92
	24.3.1	Probe interface output.....	92
	24.3.2	PHD10 hand controller.....	92
	24.3.3	RS232 communication connector.....	93
	24.3.4	IEEE communication connector.....	93
	24.3.5	Probe head connector.....	94
25		PHC10 controllers .....	95
	25.1	Description .....	95
	25.2	PHC10 communication switches.....	95
	25.2.1	RS232 communication.....	95
	25.2.2	IEEE communication.....	96
	25.3	PHC10 controller connectors .....	97
	25.3.1	Probe interface output.....	97
	25.3.2	PICS input.....	97
	25.3.3	PICS output.....	98
	25.3.4	PHD10 hand controller.....	98
	25.3.5	RS232 communication connector.....	98
	25.3.6	IEEE communication connector.....	99
	25.3.7	Probe head connector.....	99
26		PHC10-2 controllers .....	100
	26.1	Description .....	100

---

26.2	PHC10-2 communication switches .....	101
26.2.1	RS232 communication.....	101
26.2.2	IEEE communication .....	102
26.3	PHC10-2 controller connectors .....	103
26.3.1	Probe interface output .....	103
26.3.2	PICS input.....	103
26.3.3	PICS output .....	104
26.3.4	HCU1 hand control unit .....	104
26.3.5	RS232 communication connector.....	105
26.3.6	IEEE communication connector.....	105
26.3.7	Probe head connector .....	106
27	PHC50 controllers .....	107
27.1	Description .....	107
27.2	PHC50 RS232 communication switches.....	108
27.3	PHC50 controller connectors .....	109
27.3.1	Probe interface output .....	109
27.3.2	PICS input.....	110
27.3.3	PICS output .....	110
27.3.4	HCU1 hand control unit .....	111
27.3.5	HCU1 signals.....	111
27.3.6	RS232 communication connector.....	111
27.3.7	Probe head connector .....	112
28	PHS1 servo positioning head .....	113
28.1	Description .....	113
28.2	PHS1 system schematic diagram .....	114
28.3	PHS card switches .....	115
28.3.1	Old and new PHS1 cards .....	115
28.3.2	PHS1 card primary I/O map mode jumper switches.....	116
28.3.3	PHS1 card secondary I/O map mode jumper switches .....	117
28.4	PHS card connectors .....	118
28.4.1	Probe head connector .....	118
28.4.2	PICS connector.....	118
28.4.3	External 24 V DC power input connector.....	119
28.4.4	Air / stop signal input connector.....	119
28.4.5	Internal 24 V DC power input connector.....	120
29	KM1 and KM2 kinematic mounts.....	121
29.1	Description .....	121
29.2	KM1 kinematic mount connectors.....	121
29.3	Motorised head connector.....	122
29.4	PHS communication and power cable .....	122

29.5	PHS probe cable .....	123
30	Autochange controllers .....	124
30.1	Description .....	124
30.2	ACC1 controller switches .....	125
30.2.1	ACC1 RDI (rack drive interface) board .....	125
30.2.2	ACC1 RS232 serial communication switches .....	126
30.2.3	ACC1 IEEE-488 parallel communication switches .....	126
30.2.4	ACC1 stand-alone mode switches .....	127
30.2.5	Stand-alone mode selection .....	127
30.2.6	Stand-alone time delay .....	127
30.3	ACC1 controller connectors .....	128
30.3.1	SK1 probe head connector .....	128
30.3.2	PL1 - RS232 serial communication connector .....	128
30.3.3	SK2 rack RS232 communication cable connector .....	129
30.3.4	TB1 24 V DC supply .....	130
30.3.5	SK3 TTL output .....	130
30.3.6	SK3 SSR output .....	131
30.3.7	SK3 SSR output .....	132
30.3.8	SK3 OCT output .....	133
30.3.9	SK2 rack IEEE communication cable connector .....	134
30.4	ACC2 controller switches .....	135
30.4.1	ACC2 RS232 communication switches .....	135
30.4.2	ACC2 IEEE communication switches .....	136
30.4.3	ACC2 stand-alone mode switches .....	137
30.5	ACC2-2 controller switches .....	138
30.5.1	ACC2-2 RS232 communication switches .....	138
30.5.2	ACC2-2 IEEE communication switches .....	139
30.5.3	ACC2-2 stand-alone mode switches .....	140
30.6	ACC2 and ACC2-2 controller connectors .....	141
30.6.1	PICS input .....	141
30.6.2	PICS output .....	141
30.6.3	Rack communication .....	142
30.6.4	SSR output .....	143
30.6.5	Head input .....	143
30.6.6	RS232 communications .....	144
30.6.7	IEEE communications .....	144

# 1 Introduction

This guide contains information on switches, connectors and signals of conventional Renishaw interfaces and controllers.

It is of particular use to engineers involved in installation, support or upgrade activities associated with Renishaw CMM products.

For the benefit of retrofit and upgrade service providers, obsolete products have been included along with recommended upgrade unit details.

As switch and connector functions can vary between unit version levels, it is strongly advised to check the version label on units to ensure the correct switch settings or connections are enabled.

## 1.1 Renishaw CMM product support

Renishaw provides comprehensive world-wide sales and technical support through an extensive network of locally staffed subsidiary offices and regional service and repair centres, contact us:

- [www.renishaw.com/contact](http://www.renishaw.com/contact)
- [cmm.support@renishaw.com](mailto:cmm.support@renishaw.com)
- [ucc.support@renishaw.com](mailto:ucc.support@renishaw.com)

## 2 PI 4 probe interface

### 2.1 Description

The PI 4 was the first touch-trigger probe interface offering OCT (open collector transistor), TTL (transistor transistor logic) or SSR (solid state relay) output.

**It is now obsolete, having been superseded by the PI 4-2 touch-trigger probe interface.**



**WARNING:** Ensure power is removed from the PI 4 interface before gaining access to the internal SW1 and SW2 jumper switches.

### 2.2 PI 4 probe interface switches

Internal SW1 and SW2 switches enable signal and output functions to be configured to CMM requirements during initial installation. There are no user accessible switches on the rear panel.

#### 2.2.1 SW1 switches

The circuit board jumper switch SW1 enables the user to connect or disconnect the 0 V signal of the PI 4 to the supply earth. This is shown below:

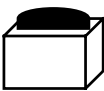
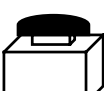
<b>SW1 Down</b> - normal 0 V signal connected to supply earth	
<b>SW1 Up</b> - Signal 0 V disconnected from supply earth	



**CAUTION:** To prevent damage to the PI 4 interface, SW2 must be set correctly.

#### 2.2.2 SW2 switches

The SW2 switch panel enables signal output type selection and is shown below:

Output	SW2 positions		
	Switch 1	Switch 2	Switch 3
OCT	OFF	ON	OFF
TTL	OFF	ON	ON
SSR	ON	OFF	OFF

## 2.3 PI 4 probe interface connectors

### 2.3.1 Probe input

The probe input connector is a 5-pin DIN-type socket. The pin numbers are shown below:

Pin number	Description
1	LED cathode
2	Ground
3	LED anode
4	Probe circuit
5	Probe circuit

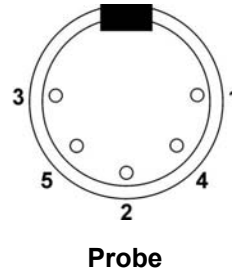

### 2.3.2 Remote HC1 input

The remote hand control or HC1 provides manual probe triggering capability.

The connector is a 5-pin DIN-type socket and the pin numbers are shown below:

Pin number	Description
1	Switch
2	Ground
3	Switch
4	+5 V (LED)
5	Not connected

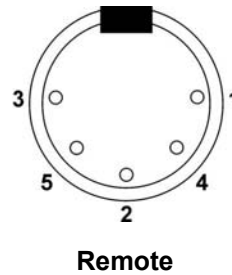

### 2.3.3 OCT (open collector transistor) output

The OCT output connector is a 5-pin DIN-type socket. The pin numbers and signal diagrams are shown below:

Open collector transistor (analogue)	
Pin number	Description
1	-
2	0 V
3	OCT

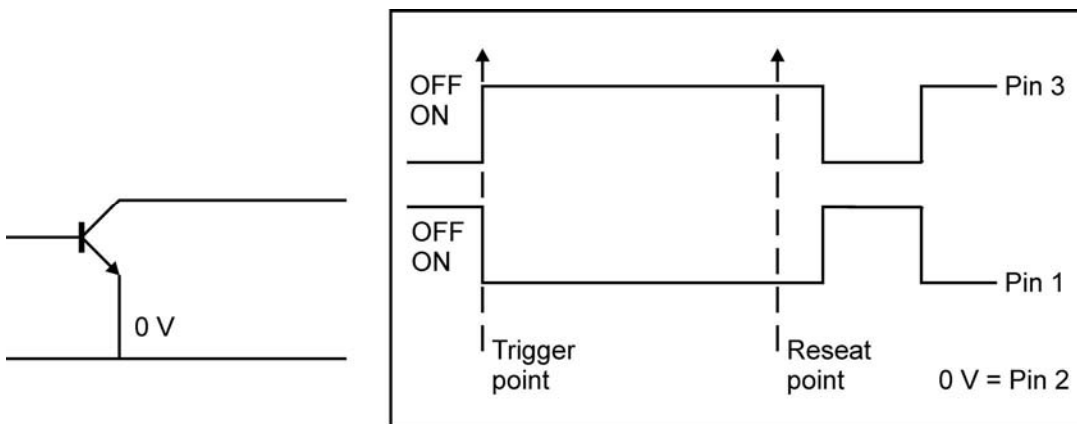
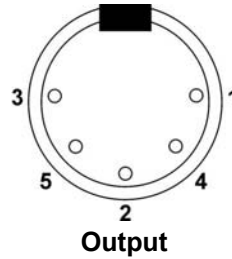

### 2.3.4 TTL (transistor transistor logic) output

The TTL (digital) output connector is a 5-pin DIN-type socket. The pin numbers and signal diagrams are shown below:

Transistor transistor logic	
Pin number	Description
1	-
2	0 V
3	TTL

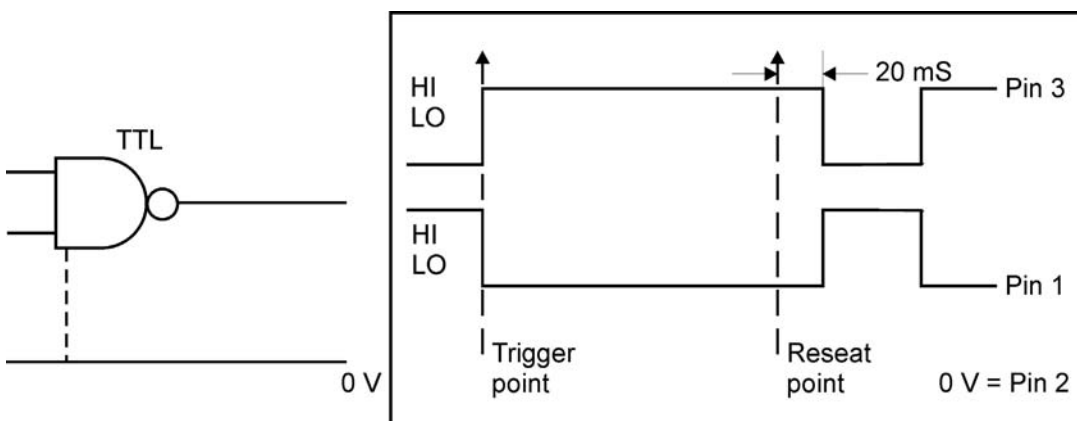
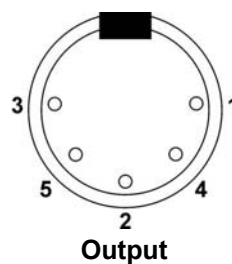



### 2.3.5 SSR (solid state relay) output

The SSR output connector is a 5-pin DIN-type socket. The pin numbers and signal diagrams are shown below:

Solid state relay	
Pin number	Description
1	-
2	0 V
3	SSR

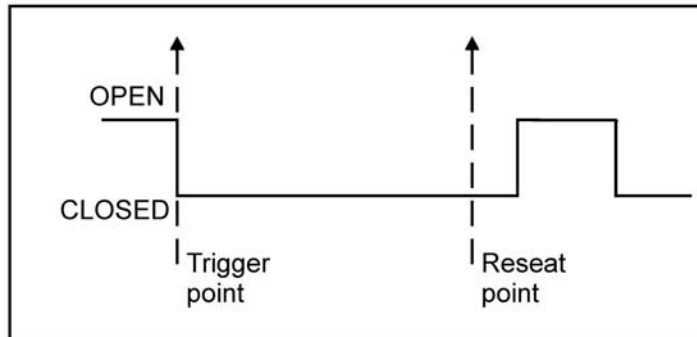
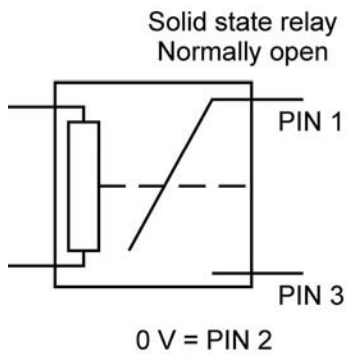
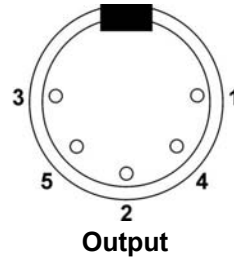

## 3 PI 9 probe interface

### 3.1 Description

The PI 9 was a touch-trigger probe interface that is now obsolete, having been replaced by the PI 4-2 interface.

Settings for the PI 9 interface were pre-configured so there are no operator enabled switches.

### 3.2 PI 9 probe interface connectors

#### 3.2.1 Input signals

The PI 9 probe signal input is via the 15-pin D-type socket connector, the pin numbers that are used are shown below:

Pin number	Description
2	LED cathode
4	Ground
7	Probe circuit
8	LED anode
15	Probe circuit

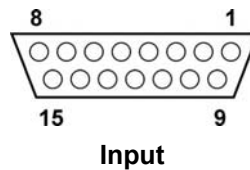

#### 3.2.2 OCT, TTL and SSR output

The PI 9 has OCT, TTL and SSR output via the single 5-pin DIN-type socket on the rear panel.

Pin number	Description		
	OCT	TTL	SSR
1	Switching on (normally off)	Low going normally high	Contact
2	Ground	Ground	Ground
3	Switching off (normally on)	High going normally low	Contact
4	-	-	-
5	-	-	-

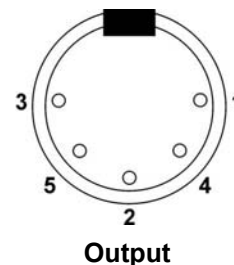

### 3.2.3 Remote HC1 input

The HC 1 remote hand control connector is a 5-pin DIN-type socket offering manual probe triggering capability, the pin numbers are shown below:

Pin number	Description
1	Switch
2	Ground
3	Switch
4	+5 V (LED)
5	Not connected

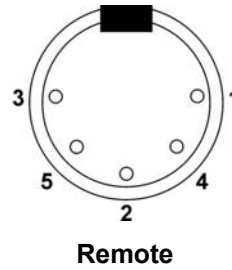

## 4 PI 4-2 probe interface

### 4.1 Description

The PI 4-2 is the current interface for standard touch-trigger probes and provides Renishaw PICS (product interconnection system) or SSR (solid state relay) output. It has replaced both the PI 4, PI 9 and PI 12 interfaces that are now obsolete.

### 4.2 PI 4-2 interface switches

The DIL switches are located on the rear panel of the PI 4-2 and are shown below:

Switch number	Position	Function
1	Up (ON)	Output polarity normal SYNC high for probe seated, low for probe triggered SSR closed for probe seated, open for probe triggered
	Down (OFF)	Output polarity reversed
2	Up (ON)	Buzzer ON
	Down (OFF)	Buzzer OFF
3 and 4	Up (ON)	Input polarity normal PICS input: Pin 5 = probe input Pin 9 = 0 V return
	Down (OFF)	Input polarity reversed PICS input: Pin 5 = 0 V return Pin 9 = probe input

**NOTE:** Although standard touch-trigger probes are not polarity sensitive, some grounding systems or special probes may require use of these switches.  
Switches 3 and 4 must be used together (both up or both down).

## 4.3 PI 4-2 probe interface connectors

### 4.3.1 PICS input

The PICS input connector is a 9-pin D-type socket with pin numbers shown below:

Pin number	Description
1	STOP
2	Probe power off (PPOFF)
3	0 V
4	Reserved for Renishaw use
5	Probe signal
6	+5 V
7	Probe damping (PDAMP)
8	LED OFF
9	Probe return
Body	SCREEN

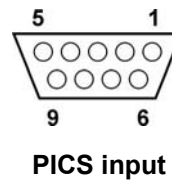

### 4.3.2 PICS output

The PICS output connector is a 9-pin D-type plug with pin numbers shown below:

Pin number	Description
1	STOP
2	Probe power off (PPOFF)
3	0 V
4	Reserved for Renishaw use
5	SYNC output (probe trigger)
6	HALT output
7	Probe damping (PDAMP)
8	LED OFF
9	-
Body	SCREEN

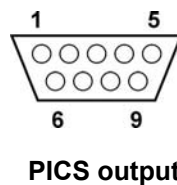

### 4.3.3 SSR output

The SSR output connector is a 5-pin DIN-type socket with pin numbers shown below:

Pin number	Description
1	Probe status (a)
2	Screen
3	Probe status (b)
4	Probe status (a)
5	Probe status (b)

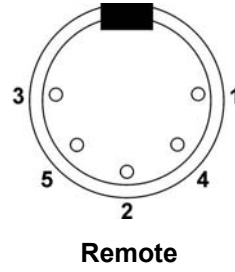

## 5 PI 6 probe interface

### 5.1 Description

The Renishaw PI 6 is an in-line ‘dongle’ type interface that can be fitted to the parallel 25-pin connector of a CMM PC to provide basic signal conditioning for standard touch-trigger probes. Input and output signals of the CMM must conform to electrical specifications for open collector devices.

### 5.2 PI 6 probe interface connections

#### 5.2.1 CMM signal

The CMM signal connector is a 25-pin D-type socket with pin numbers shown below:

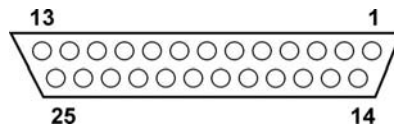

Pin number	Signal	Signal direction	Description
1	Shield	From CMM	Cable shield
7	0 V	From CMM	Power supply: ground
13	+12 V	From CMM	Power supply: +12 V
17	SYNC	To CMM	Trigger event: active low
19	+5 V	From CMM	Power supply: +5 V
22	Probe inhibit	From CMM	Probe inhibit system: active low

#### 5.2.2 Probe signal

The probe signal connector is a 25-pin D-type plug with pin numbers shown below:

Pin number	Description
1	Cable shield
7	Power supply: ground
13	Power supply: +12 V
17	Trigger event: active low
19	Power supply: +5 V
22	Probe inhibit system: active low

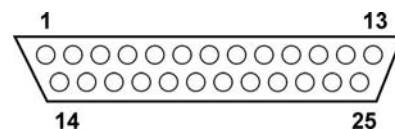

## 5.3 PI 6 specifications

### 5.3.1 Environmental specification

Operating temperature range is from 5 °C to 50 °C (40 °F to 120 °F).

### 5.3.2 Screening

Both connector bodies are connected to pin 1 (shield).

It is recommended that the probe cable and (if applicable) the CMM cable are screened by connecting to pin 1. If a CMM cable is used, link pin 1 (shield) to pin 7 (0 V) at the PI 6 end of the cable to increase immunity from electromagnetic interference.

### 5.3.3 Electrical specification

Supply voltages    +12 V (±5%)        +5 V (±5%)

Supply current    26 mA (max)        40mA (max)

### 5.3.4 PI 6 signal outputs

The PI 6 output signal diagram is detailed below:

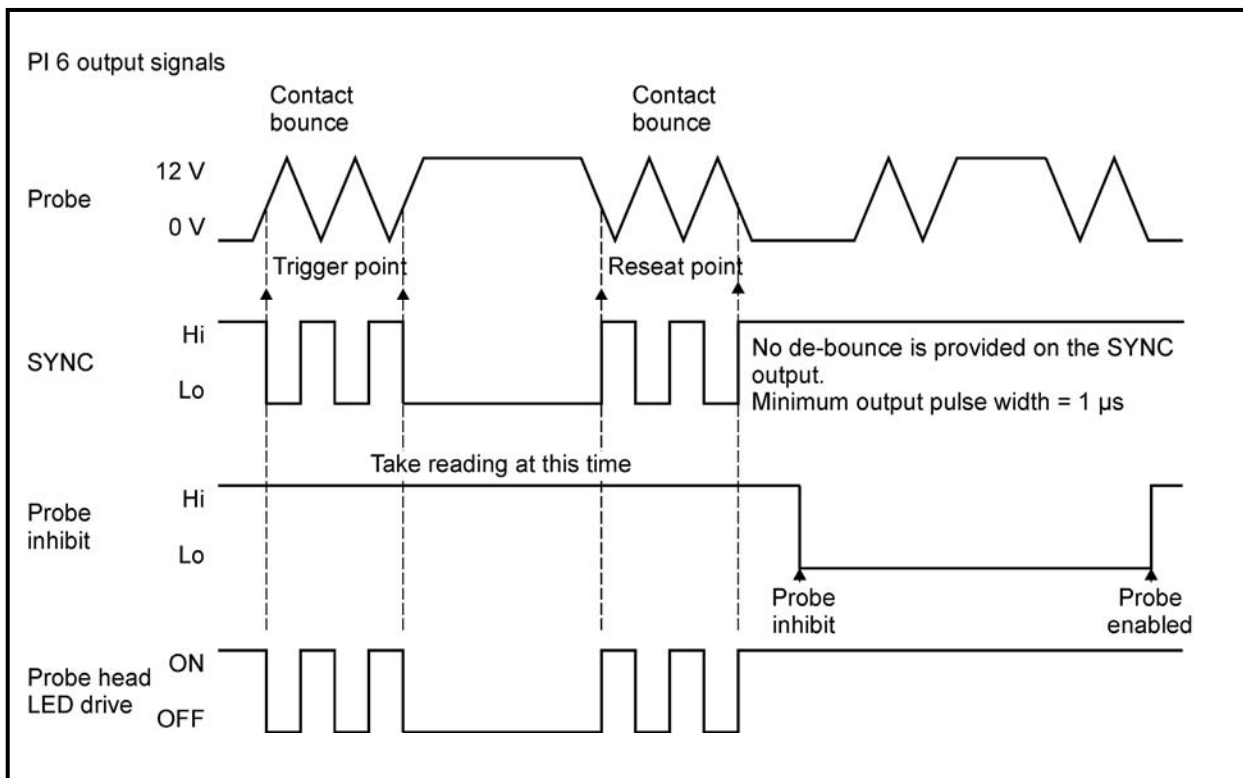



## 6 PI 12 probe interface

### 6.1 Description

The PI 12 interface was used for signal conditioning of the TP12 piezo probes. It was compatible with the early PICS systems and could also recognise and condition standard touch-trigger probe signals for either PICS or SSR output.

The PI 12 interface is now obsolete, having been replaced by the PI 4-2.

### 6.2 PI 12 probe interface switches

The DIL switches are located on the rear panel of the PI 12 and are shown below:

Switch number	Position	Function
1	Down ON	0 V connected via chassis to mains earth
	Up OFF	0 V isolated from chassis mains earth
2	Down ON	SSR CLOSED when probe seated, OPEN when triggered
	Up OFF	SSR OPEN when probe seated, CLOSED when triggered
3	Down ON	Buzzer sounds for 200 mS when probe is triggered
	Up OFF	Buzzer sounds for 200 mS but will stay on if a probe error is detected  <b>NOTE:</b> The buzzer will reset when the next measurement signal is detected.
4	Down ON	Default position, reserved for future Renishaw use

## 6.3 PI 12 probe interface connectors

### 6.3.1 PICS input

The PICS input signal connector is a 9-pin D-type socket with pin numbers shown below:

Pin number	Description
1	STOP
2	Probe power off (PPOFF)
3	0 V
4	Reserved for Renishaw use
5	Probe signal
6	+5 V
7	Probe damping (PDAMP)
8	LED OFF
9	Probe return
Body	SCREEN

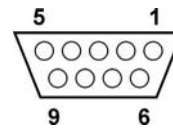

**PICS input**

### 6.3.2 PICS output

The PICS output signal connector is a 9-pin D-type plug with the pin numbers shown below:

Pin number	Description
1	STOP
2	Probe power off (PPOFF)
3	0 V
4	Reserved for Renishaw use
5	Synchronisation (input to CMM)
6	Probe error flag
7	Probe damping (PDAMP)
8	LED OFF
9	Trigger (output from CMM)
Body	SCREEN

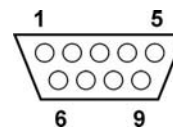

**PICS output**

### 6.3.3 SSR output

The SSR output signal connector is a 5-pin DIN-type socket with the pin numbers shown below:

Pin number	Description
1	Probe error
2	Screen
3	Probe error
4	Probe status output
5	Probe status output

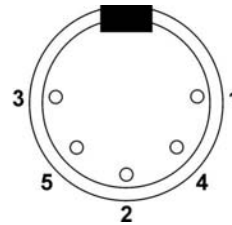

**Remote**

**NOTE:** Pins 1 and 3 are probe error pins normally open. Pins 4 and 5 are probe status output pins.

## 7 PI 200 probe interface, version 4 to version 8

### 7.1 Description

The version 4 to version 8 PI 200 interfaces were the original types used for signal conditioning of the TP200 and TP200B strain gauge probes and for operation of the optional SCR200 stylus change rack. They also provided PICS or SSR output and signal conditioning of standard touch-trigger probes.



#### CAUTION:

- 1) Check the PI 200 version as the switch information shown below is for version 4 to version 8 units only. Later versions have different functions for some switches.
- 2) All stylus tips must be re-qualified if trigger level switches are altered.

The version 4 to 8 DIL switches are detailed below:

Switch number		Position	Function
1	HALT invert	Switch DOWN Switch UP	HALT LOW on trigger HALT HIGH on trigger
2	LED bypass	Switch DOWN Switch UP	PI 200 drives head LED in accordance with SYNC Head LED control goes to PICS only
3	STOP disable	Switch DOWN Switch UP	Trigger output response to STOP Trigger output response to STOP disabled
4	Output divert	Switch DOWN Switch UP	SYNC, LOW, SSR OPEN on trigger SYNC HIGH, SSR CLOSE on trigger
5	Buzzer OFF	Switch DOWN Switch UP	Audible indication of probe trigger No audible indication except extended probe trigger warning
6	De-bounce mode	These switches used together allow optimum selection of four trigger and re-seat optimum timings (see next page)	
7	De-bounce timing		
8	Zero de-bounce	Switch DOWN Switch UP	Inactive Reduces output de-bounce times on trigger and re-seat to less than 2 mS which overrides the switch 6 function
9	Trigger filter	Switch DOWN Switch UP	Inactive 300 $\mu$ s filter active
10	Reserved	Switch DOWN Switch UP	Reserved for Renishaw use
11	Trigger level	Switch DOWN Switch UP	Trigger level 1 standard sensitivity Trigger level 2 reduced sensitivity
12	PDAMP/HALT filter timing	Switch DOWN Switch UP	15 ms timing 50 ms timing

## 7.2 PI 200 probe interface version 4 to version 8 switches

The diagram below shows the effect of switches 6 and 7 on SYNC (synchronisation) signal outputs:

### SYNC (synchronisation signal) de-bounce options

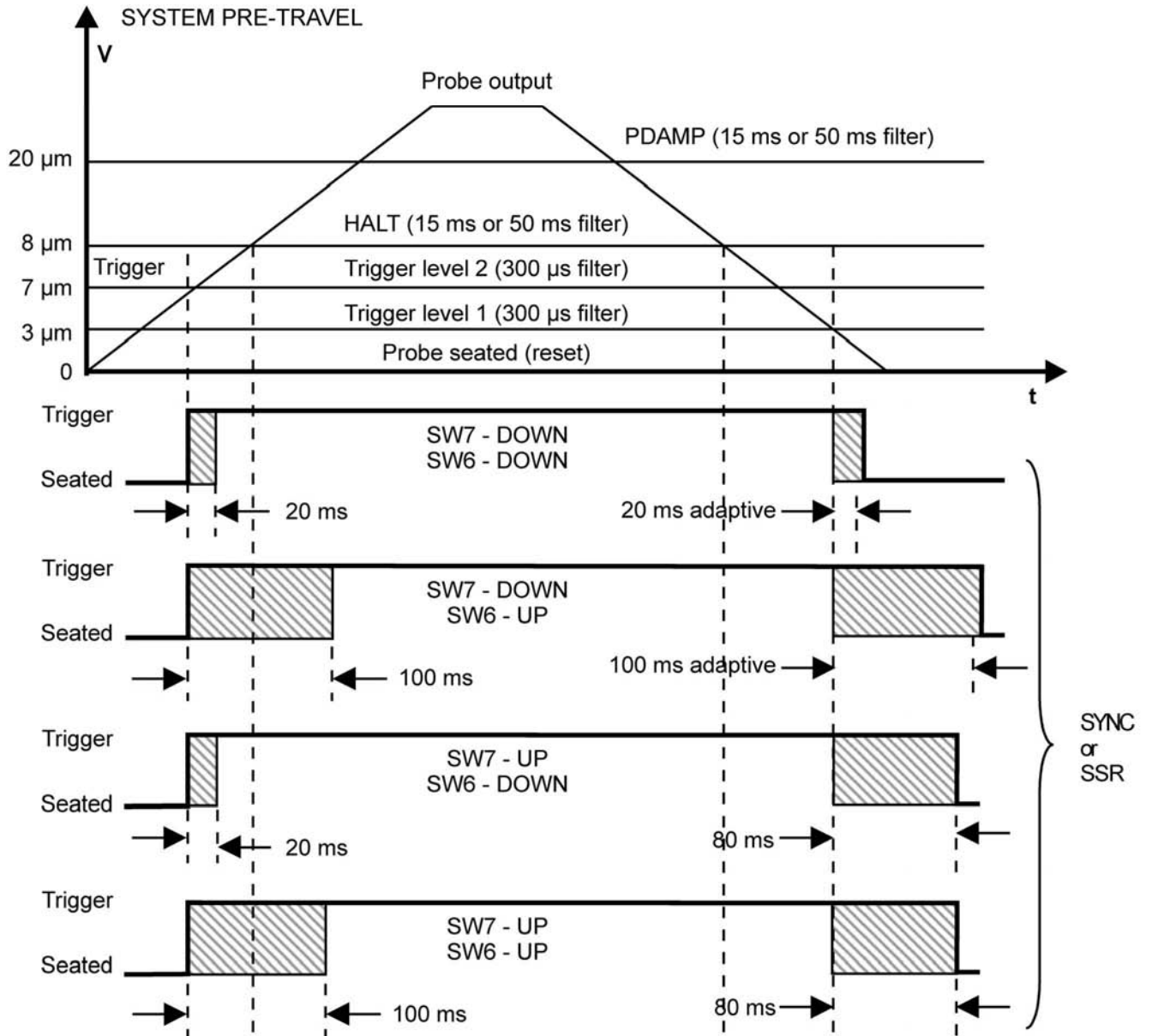

## 7.3 PI 200 probe interface, version 9 and later

### 7.3.1 Description

The version 9 and later PI 200 interfaces are now used for signal conditioning of the TP200 and TP200B strain gauge probes and operation of the SCR200 stylus change rack. They also provide PICS or SSR output and signal conditioning of standard touch-trigger probes.



#### CAUTION:

- 1) Check the PI 200 version as the switch information shown below is for version 9 units or later. Earlier versions have different functions for some switches.
- 2) All stylus tips must be re-qualified if trigger level switches are altered.

## 7.4 PI 200 version 9 and later interface switches

The DIL switches are located on the rear panel of the PI 200 and are shown below:

Switch number		Position	Function
1	HALT polarity	Switch UP Switch DOWN	HALT active HIGH HALT active LOW
2	Head LED control	Switch UP Switch DOWN	External control via PICS LED mimics SYNC
3	STOP disable	Switch UP Switch DOWN	PI 200 ignores PICS – STOP STOP asserts HALT/SYNC
4	SYNC polarity	Switch UP Switch DOWN	SYNC HIGH, SSR closes on trigger SYNC LOW, SSR opens on trigger
5	Buzzer OFF	Switch UP Switch DOWN	No beep on trigger Audible beep on trigger
6	De-bounce timing	See next page	Selects SYNC de-bounce time
7	De-bounce mode	See next page	Selects SYNC de-bounce time
8	Zero de-bounce	Switch UP Switch DOWN	Sets de-bounce time to <2 ms De-bounce set by switches 6 and 7
9	Probe signal filter	Switch UP Switch DOWN	Filter active Filter off
10	Trigger level	Switch UP Switch DOWN	Trigger level 2 selected Trigger level 1 selected
11 and 12	PDAMP / HALT filter timing	Switch 11 and 12 down Switch 11 down and 12 up Switch 11 up and 12 down Switch 11 and 12 up	2.0 ms 7.5 ms 15.0 ms 50.0 ms

The diagram below shows the effect of switches 6 and 7 on SYNC (synchronisation) signal outputs:

**SYNC (synchronised signal) de-bounce options**

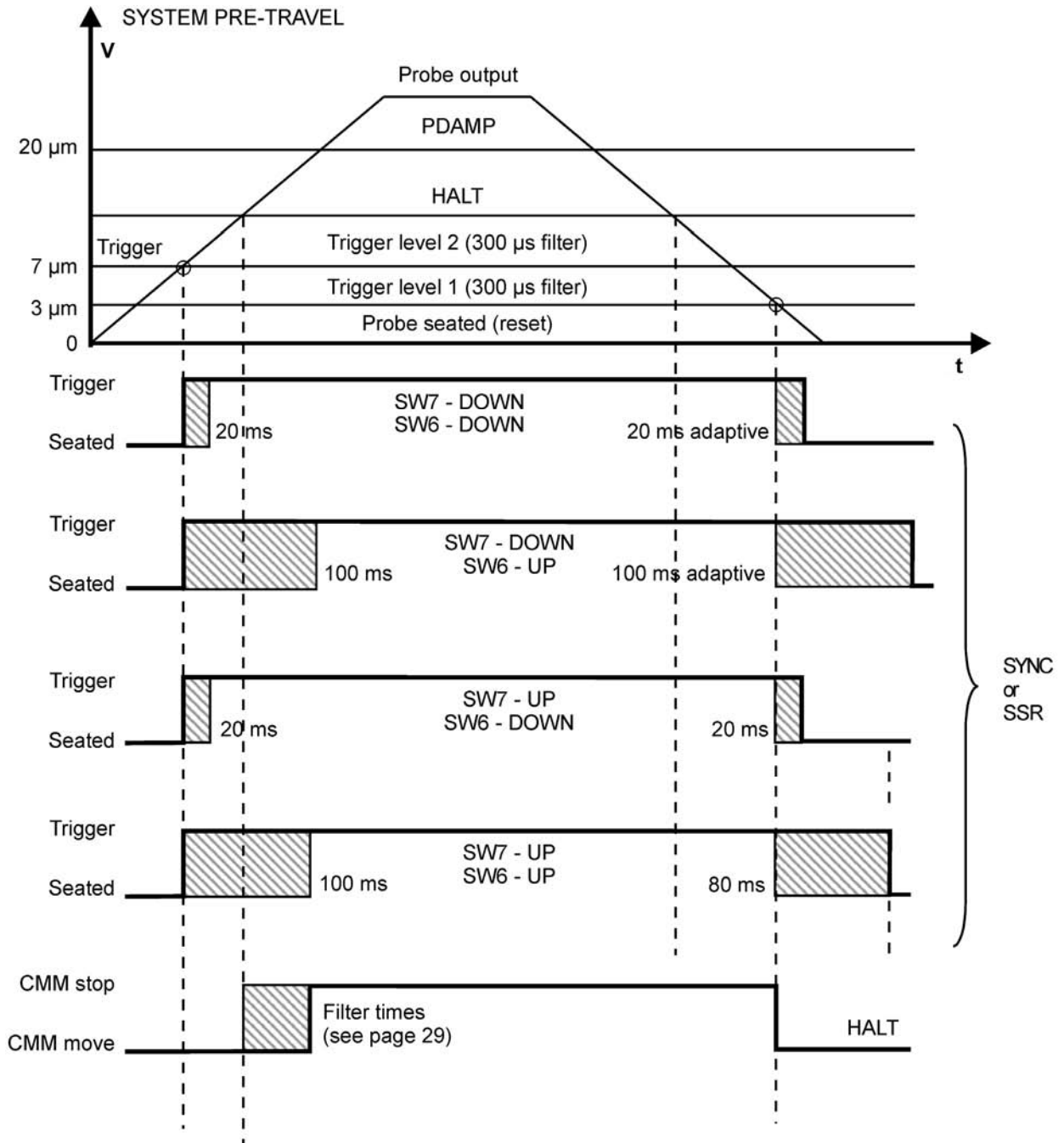

## 7.5 PI 200 probe interface connectors, all versions

### 7.5.1 PICS input

The PICS input signal connector is a 9-pin D-type socket with the pin numbers shown below:

Pin number	Description
1	STOP
2	Probe power off (PPOFF)
3	0 V
4	Reserved for Renishaw use
5	Probe signal
6	+5 V
7	Probe damping (PDAMP)
8	LED OFF
9	Probe return
Body	SCREEN

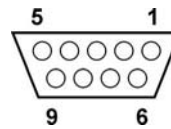

**PICS input**

### 7.5.2 PICS output

The PICS output signal connector is a 9-pin D-type plug with the pin numbers shown below:

Pin number	Description
1	STOP
2	Probe power off (PPOFF)
3	0 V
4	Reserved for Renishaw use
5	SYNC output (probe trigger)
6	HALT output
7	Probe damping (PDAMP)
8	LED OFF
9	-
Body	SCREEN

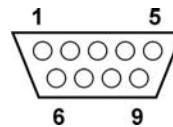

**PICS output**



### 7.5.3 SSR output

The SSR output signal connector is a 7-pin DIN-type socket with the pin numbers shown below:

Pin number	Description
1	-
2	Screen
3	-
4	Probe status
5	Probe status
6	-
7	-

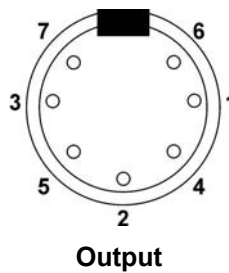

### 7.5.4 SCR200 rack

The SCR200 signal connector is a 6-pin miniature DIN-type socket with the pin numbers shown below:

Pin number	Description
1	Remote set
2	Error
3	Inhibit
4	Power
5	0 V
6	-

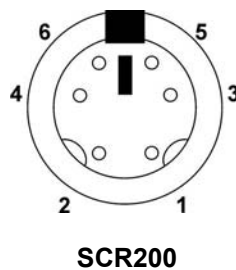

## 8 VPI 1 video probe interface

### 8.1 Description

The VPI 1 was the first design of video probe interface and was used to generate images from either the VP1M or VP2 CCD cameras and for conditioning the signals from standard touch-trigger probes. Output signals were either PICS or SSR.

**All video probe systems are now obsolete.**

### 8.2 VPI 1 video probe interface switches

The DIL switches are located on the rear panel of the VPI 1 and are shown below:

Switch number	Function	
	Up	Down
1	VP1M – 525 version camera (for 60 Hz mains frequency)	VP1M – 625 version camera (for 50 Hz mains frequency)
2	Probe head LED normally ON	Probe head LED normally OFF
3	VPI 1 connected to standard touch-trigger probes via INPUT socket	VPI 1 connected to standard VIDEO trigger probes via PICS PROBE socket
4	VPI 1 connected to probe head PROBE LED via PROBE HEAD socket	VPI 1 connected via VIDEO socket
5	Internal buzzer OFF	Internal buzzer ON
6	SSR output normally OPEN	SSR output normally CLOSED

### 8.3 VPI 1 video probe interface connectors

#### 8.3.1 75 Ohm co-axial output connector

This takes the 75 Ohm analogue video output signal to either a black and white monitor or to a video capture card in the CMM PC for further image processing. It only provides an image as the graticule overlays are not part of this signal.

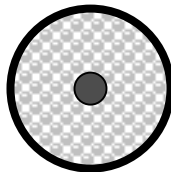

### 8.3.2 Video probe input connector

The video probe input connector is a 15-pin high density D-type socket with the following pin numbers shown below for either VP1M or VP2 camera types:

Pin number	Description	
	VP1M camera	VP2 camera
1	Reference	Reference
2	Overall screen	Overall screen
3	Identification 0 V	Identification 0 V
4	Signal 2	-
5	Signal 3	-
6	+12 V	+12 V
7	Illumination supply	Illumination supply
8	Identification	Identification
9	Video 0 V	Video 0 V
10	Video output	Video output
11	Signal 1	-
12	Probe sense return	Probe sense return
13	Probe input	-
14	LED anode	-
15	LED cathode	-

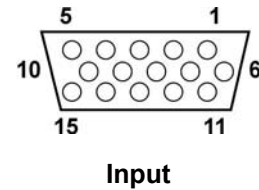

### 8.3.3 Manual head input connector

The manual probe input is a 7-pin DIN-type socket connector with the pin numbers detailed below:

Pin number	Description
1	Probe head LED cathode
2	Screen
3	Probe head LED anode
4	Probe circuit
5	Probe circuit
6	Remote inhibit
7	Remote inhibit

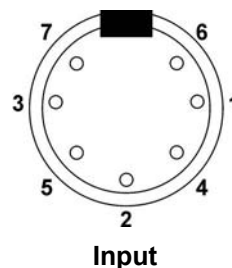

### 8.3.4 PICS input

The video probe PICS input is a 9-pin D-type socket connector with the pin numbers shown below:

Pin number	Description
1	E STOP
2	Probe power off (PPOFF)
3	0 V reference line
4	LED anode
5	Probe signal input
6	+5 V
7	Probe damping (PDAMP)
8	LED OFF
9	Probe signal return (connected to 0 V)
Body	Screen

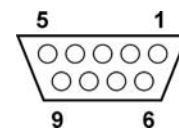

**PICS input**

### 8.3.5 PICS output

The video probe PICS output is a 9-pin D-type plug connector with the pin numbers shown below:

Pin number	Description
1	E STOP
2	Probe power off (PPOFF)
3	0 V reference line
4	No function, terminated with 2K7 pull up resistor to +5 V
5	SYNC output (probe trigger)
6	HALT output
7	Probe damping (PDAMP)
8	LED OFF
9	No function, terminated with 2K7 pull up resistor to +5 V
Body	Screen

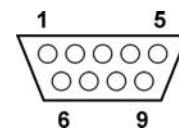

**PICS output**

### 8.3.6 Manual control and HC1 switch

The manual control footswitch or HC1 hand control input signals use a 5-pin DIN-type socket with the pin numbers of this connector shown below:

Pin number	Description
1	-
2	Screen
3	-
4	Switch and LED
5	-

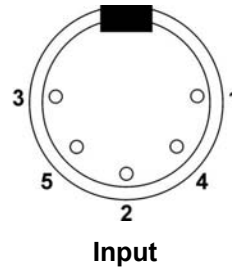

### 8.3.7 SSR output

The SSR probe signal output is a 5-pin DIN-type socket connector with the pin numbers shown below:

Pin number	Description
1	-
2	-
3	-
4	SSR
5	SSR

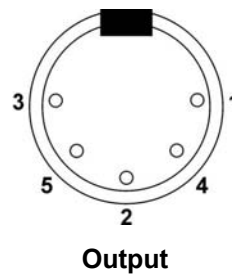

## 9 VPI 2 video probe interface

### 9.1 Description

The VPI 2 video probe interface was used for generating images from either the VP1M or VP2 CCD cameras and for conditioning the signals from standard touch-trigger probes. It had adjustable graticule overlays for comparison measurements and Z axis measurement capability when using the LSZ1 lens module. It used an SVGA monitor for image display and provided PICS and SSR probe signal outputs.

### 9.2 VPI 2 video probe interface SW1 switches

The DIL SW1 switches are located on the rear panel of the VPI 2 and are shown below:

Switch number	Function	
	Up	Down
1	VPI 2 connected to standard touch-trigger probes via PICS IN socket	VPI 2 connected to video touch-trigger probe via the probe cable
2	PICS SYNC signal is inverted	Normal PICS SYNC
3	PICS HALT signal is inverted	Normal PICS HALT
4	Normal PICS touch-trigger PROBE DAMPING	PICS PROBE DAMPING disables video triggering in addition to normal touch-trigger PROBE DAMPING
5	VPI 2 will not respond to external PICS EMERGENCY STOP signal	Normal PICS EMERGENCY STOP position
6	Internal buzzer OFF.	Internal buzzer ON

### 9.3 VPI 2 video probe interface SW2 switches

Switch number	Function					
<b>SW2</b>	<b>Up</b>			<b>Down</b>		
1	VP2 – 525 version camera (for 60 Hz mains frequency)			VP2 – 625 version camera (for 50 Hz mains frequency)		
	<b>RS232 Baud rate setting</b>					
	300	600	1200	2400	4800	9600
2	DOWN	UP	DOWN	UP	DOWN	UP
3	DOWN	DOWN	UP	UP	DOWN	DOWN
4	DOWN	DOWN	DOWN	DOWN	UP	UP
<b>SW2</b>	<b>Up</b>			<b>Down</b>		
5	RS232 XON/XOFF enabled			RS232 RTS/CTS enabled		
6	Not used			Not used		
7	Not used			Not used		
8	Probe head LED normally OFF			Probe head LED normally ON		

**NOTE:** There are no VPI 2, IEEE communication versions.

### 9.4 VPI 2 video probe interface connectors

#### 9.4.1 75 Ohm co-axial output connector

This takes the 75 Ohm analogue video output signal to either a black and white monitor or to a video capture card in the CMM PC for further image processing. It only provides an image as the graticule overlays are not generated with this signal output.

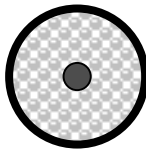

### 9.4.2 Video probe input connector

The video probe input connector is a 15-pin high density D-type socket with the pin numbers shown below for VP1M or VP2 camera types:

Pin number	Description	
	VP1M camera	VP2 camera
1	Reference	Reference
2	Overall screen	Overall screen
3	Identification 0 V	Identification 0 V
4	Signal 2	-
5	Signal 3	-
6	+12 V	+12 V
7	Illumination supply	Illumination supply
8	Identification	Identification
9	Video 0 V	Video 0 V
10	Video output	Video output
11	Signal 1	-
12	Probe sense return	Probe sense return
13	Probe input	-
14	LED anode	-
15	LED cathode	-

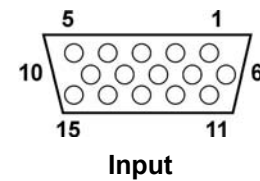

### 9.4.3 Manual head input connector

The manual probe input is a 7-pin DIN-type socket connector with the pin numbers detailed below:

Pin number	Description
1	Probe head LED cathode
2	Screen
3	Probe head LED anode
4	Probe circuit
5	Probe circuit
6	Remote LED
7	Remote inhibit

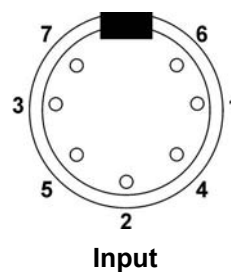



#### 9.4.4 PICS input

The video probe PICS input is a 9-pin D-type socket connector with the pin numbers shown below:

Pin number	Description
1	E STOP
2	Probe power off (PPOFF)
3	0 V reference line
4	LED anode
5	Probe signal input
6	+5 V
7	Probe damping (PDAMP)
8	LED OFF
9	Probe signal return (connected to 0 V)
Body	Screen

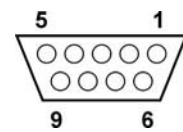

**PICS input**

#### 9.4.5 PICS output

The video probe PICS output is a 9-pin D-type plug connector with the pin numbers shown below:

Pin number	Description
1	E STOP
2	Probe power off (PPOFF)
3	0 V reference line
4	No function, terminated with 2K7 pull up resistor to +5 V
5	SYNC output (probe trigger)
6	HALT output
7	Probe damping (PDAMP)
8	LED OFF
9	No function, terminated with 2K7 pull up resistor to +5 V
Body	Screen

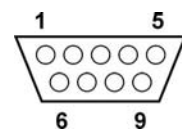

**PICS output**

### 9.4.6 Manual control and HC1 switch

The manual control footswitch or HC1 hand control input signals use a 5-pin DIN-type socket. Pin numbers for this connector are shown below:

Pin number	Description
1	-
2	Screen
3	-
4	Switch and LED
5	-

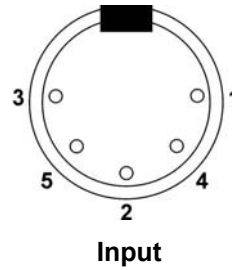

### 9.4.7 SSR output

The SSR probe signal output is a 5-pin DIN-type socket connector with the pin numbers shown below:

Pin number	Description
1	-
2	Screen
3	-
4	SSR
5	SSR

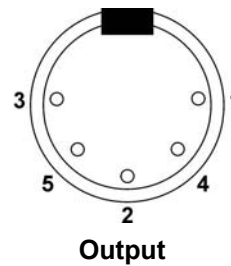

## 10 OPI 6 probe interface

### 10.1 Description

The pre-version 4 type OPI 6 was the first iteration of interface for the OTP6M multiwire non-contact laser optical triggering probe. It supplied power to the probe and conditioned the signal outputs. It could also be used for signal conditioning of standard touch-trigger probes and provided PICS or SSR output.

### 10.2 OPI 6 probe interface, pre-version 4 switches



**CAUTION:** Check the OPI 6 version number on rear panel. The switch information shown below refers to OPI 6 version 4 or earlier. Later versions have different functions for some switches.

The DIL switches on the pre-version 4 type OPI6 are located on the rear panel and are shown below:

Switch number	Position	Function
1	Up (ON)	Output polarity normal SYNC high for probe seated, low for probe triggered SSR closed for probe seated, open for probe triggered
	Down (OFF)	Output polarity reversed
2	Up (ON)	OPI 6 connected to standard touch-trigger probes via PICS in socket
	Down (OFF)	OPI 6 connected to standard and multiwired probes via the probe cable
3	Up (ON)	Normal PICS STOP position
	Down (OFF)	OPI 6 will not assert trigger in response to an external PICS STOP signal
4	Up (ON)	Internal buzzer ON
	Down (OFF)	Internal buzzer OFF

## 10.3 OPI 6 probe interface, post-version 4 switches

### 10.3.1 Description

The post-version 4 OPI 6 interface is the current unit for the OTP6M multiwire non-contact laser optical triggering probe. It supplies power to the probe and conditions the signal outputs. It can also condition signals for standard touch-trigger probes and provides PICS or SSR output.

## 10.4 OPI 6 probe interface, post-version 4 switches



**CAUTION:** Check the OPI 6 version number on rear panel. The switch information shown below refers to post-version 4 OPI 6 units. Earlier OPI 6 versions have different functions for some switches.

The DIL switches on the post-version 4 type OPI6 are located on the rear panel and are shown below:

Switch number	Position	Function
1	Up (ON)	Output polarity normal SYNC high for probe seated, low for probe triggered SSR closed for probe seated, open for probe triggered
	Down (OFF)	Output polarity reversed
2	Up (ON)	OPI 6 connected to standard touch-trigger probes via PICS in socket
	Down (OFF)	OPI 6 connected to standard and multiwired probes via the probe cable
3	Up (ON)	Normal PICS STOP position
	Down (OFF)	OPI 6 will not assert trigger in response to an external PICS STOP signal
4	Up (ON)	Internal buzzer ON
	Down (OFF)	Internal buzzer OFF

## 10.5 OPI 6 probe interface connectors, all versions

### 10.5.1 PICS input

The PICS input signal connector is a 9-pin D-type socket with the pin numbers shown below:

Pin number	Description
1	STOP
2	Probe power off (PPOFF)
3	0 V
4	Reserved for Renishaw use
5	Probe signal
6	+5 V
7	Probe damping (PDAMP)
8	LED OFF
9	Probe return
Body	Screen

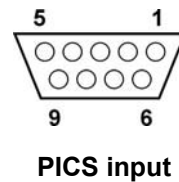

### 10.5.2 PICS output

The PICS output signal connector is a 9-pin D-type plug with the pin numbers shown below:

Pin number	Description
1	STOP
2	Probe power off (PPOFF)
3	0 V reference line
4	Reserved for Renishaw use
5	SYNC output (probe trigger)
6	HALT output
7	Probe damping (PDAMP)
8	LED OFF
9	-
Body	Screen

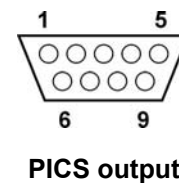

**CAUTION:** This CMM input/output connector does NOT have the same function on pins 1, 3, 6 and 7 as the PHC9 and PHC10 or any Renishaw interface. Incorrect connection may affect systems performance or cause damage to associated equipment.

### 10.5.3 CMM input/output connector

The CMM input/output connector is a 7-pin DIN-type socket with the pin numbers detailed below:

Pin number	Description
1	3D mode select (see note 2)
2	Screen
3	Reserved for Renishaw use
4	SSR
5	SSR return
6	In-range output (see note 1)
7	Error output (see note 3)

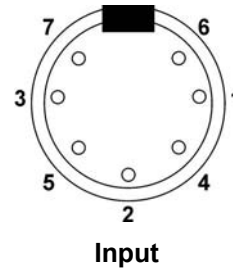

#### NOTE:

- 1) When the probe is operating within its working range, the 'in-range' output is 5 V (at all other times it is 0 V). An explanation of the 'in-range' output is given in the H-1000-5007-01-A user's guide.
- 2) The 3D Mode is selected by connecting pin 1 to pin 2 (screen). An explanation of 1D and 3D modes are detailed in the relevant user's guide H-1000-5007-01-A.
- 3) When errors occur this output is 5V (at all other times, 0 V).

### 10.5.4 Probe head input connector

The probe head input connector is a 15-pin high density D-type socket with pin numbers detailed below:

Pin number	Description
1	1D / 3D select
2	Linked to pin 2 of 'interface' output
3	0 V A
4	Linked to pin 4 of 'interface' output
5	'In-range' signal line
6	Probe power
7	Linked to pin 7 of 'interface' output
8	To probe identification circuit
9	Linked to pin 9 of 'interface' output
10	Linked to pin 10 of 'interface' output
11	Error signal line
12	0 V reference
13	2 wire trigger signal line
14	Head LED anode
15	Head LED anode return

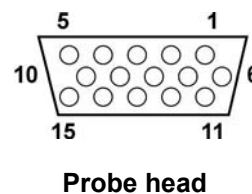

### 10.5.5 Interface output connector

The interface output connector is a 15-pin high density D-type plug with the pin numbers detailed below:

Pin number	Description
1	1D / 3D select
2	Linked to pin 2 of 'interface' output
3	0 V A
4	Linked to pin 4 of 'interface' output
5	'In-range' signal line
6	Probe power
7	Linked to pin 7 of 'interface' output
8	To probe identification circuit
9	Linked to pin 9 of 'interface' output
10	Linked to pin 10 of 'interface' output
11	Error signal line
12	0 V reference
13	2 wire trigger signal line
14	Head LED anode
15	Head LED anode return

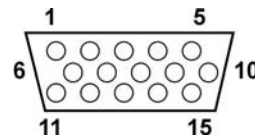

**Interface**

## 11 PI 7 probe interface

### 11.1 Description

The PI 7 was the initial interface type used with TP7M multiwire strain gauge probes. It conditioned the signal outputs for TP7M and standard touch-trigger probes, providing either PICS or SSR output.

**The PI 7 is obsolete, having been replaced by the PI 7-2 interface.**

### 11.2 PI 7 probe interface switches

**CAUTION:** All stylus tips must be requalified if the 'mid-sensitivity' or 'auto-reset' switches are altered.

The DIL switches on the PI 7 interface are located on the rear panel and are shown below:

Switch number		Description	Function	
1	Grounding	Down ON	0 V connected via the chassis to the mains earth	
		Up OFF	0 V isolated from mains earth	
2	SSR	Down ON	SSR open for seated probe and closed for probe triggered	
		Up OFF	SSR closed for seated probe and open for triggered probe	
3	Mid sensitivity	Down ON	PI 7 set for high sensitivity threshold	
		Up OFF	PI 7 set for mid sensitivity threshold, this allows TP7 to be used on CMMs not using probe DAMPING via PICS	
4 and 5	Auto reset	Used in combination for selecting one of three time periods before automatic re-seating of the probe occurs:		
		Switch 4	Switch 5	
		ON (down)	ON (down)	Not selected
		On (down)	OFF (up)	1 second
		OFF (up)	ON (down)	2 seconds
		OFF (up)	OFF (up)	3 seconds
6	Input selection	Down ON	Probe input via 15-pin high-density 'D' with multiwire TP7 probe cable	
		Up OFF	Probe input via PICS	



## 11.3 PI 7 interface connections

### 11.3.1 PICS input

The PICS input signal connector is a 9-pin D-type socket with pin numbers shown below:

Pin number	Description
1	STOP
2	Probe power off (PPOFF)
3	0 V
4	Reserved for Renishaw use
5	Probe signal
6	+5 V
7	Probe damping (PDAMP)
8	LED OFF
9	Probe
Body	Screen

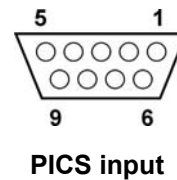

**NOTE:** When used in conjunction with a PH6M fixed multiwire probe head it is necessary to make two connection links on the PI 7 PICS INPUT:

- a) Link pin 6 (+5V) to pin 1 (STOP) on the input cable connector to provide a pull-up resistance signal that is normally provided by PHC10-2 controllers on motorised head systems.
- b) Link pin 4 to pin 8, to enable the PH6M head LED drive circuit to operate.

### 11.3.2 PICS output

The PICS output connector is a 9-pin D-type plug with pin numbers shown below:

Pin number	Description
1	STOP
2	Probe power off (PPOFF)
3	0 V
4	Reserved for Renishaw use
5	SYNC output (probe trigger)
6	HALT output
7	Probe damping (PDAMP)
8	LED OFF
9	-
Body	Screen

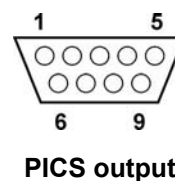

### 11.3.3 Probe input

The TP7M multiwire strain gauge probe input connector is a 15-pin high density D-type socket with pin numbers shown below:

Pin number	Description
1	Reference
2	Overall screen
3	2 wire probe signal / probe ident return
4	Uncommitted
5	Uncommitted
6	Uncommitted
7	Uncommitted
8	Probe identification
9	Co-axial screen
10	75 Ohm co-axial inner
11	Uncommitted
12	Uncommitted
13	2 wire probe signal
14	Not connected to probe
15	Not connected to probe

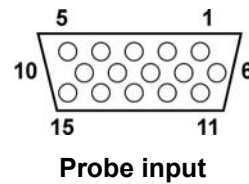

### 11.3.4 SSR output

The SSR output is a 5-pin DIN-type socket connector with the pin numbers shown below:

Pin number	Description
1	-
2	Screen
3	-
4	Probe status output
5	Probe status output

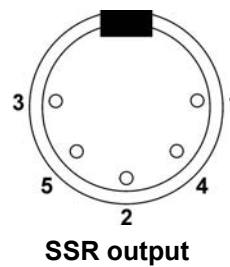

---

## 12 PD1 and PD7 interface modules

### 12.1 Description

The PI 7 interface used PD1 and PD7 modules that are now obsolete, they were used as follows:

PD1 - For de-coupling the SYNC output signal allowing parallel connection of Renishaw interfaces. It was used in systems requiring an interface selector (IS1). The PD1 was installed between the interface, controller and the PICS cables by direct connection to the PICS output on the rear of the PI 7 interface.

PD7 - For selectively filtering the application of the PROBE DAMPING signal input to the TP7M probe system. It was used in installations where PROBE DAMPING could be applied while the probe was still in contact with the part.

When installed, the PD7 only allowed the damping signal (PICS pin 7 - PDAMP) to enter the system when a PROBE SEATED condition was indicated on the PROBE STATUS line (PICS pin 5 - SYNC). With the exception of DAMPING, all PICS signals were unaffected. The PD7 was fitted between the PI 7 and the PICS cable by direct connection to the PICS output connector of the PI 7 interface (early versions only).

---

**IMPORTANT:** Where a PD7 is fitted, the PD1 must be furthest from the unit. Applications used are OP5, PC1M, PI 7 and IS1 (very early units only) and ACC2 when TP800 and PI 800 are used.

---

**The PD1 and PD7 modules are now obsolete and have been incorporated in the PI 7-2 interface.**

## 13 PI 7-2 probe interface, pre-version 13

### 13.1 Description

The pre-version 13 PI 7-2 was the intermediate interface for TP7M multiwire strain gauge probes. Used for conditioning the signal outputs of TP7M and standard touch-trigger probes, it also provided PICS and SSR signal outputs with the functions of the old PD1 and PD7 incorporated. It has been superseded by the current version 13 PI 7-2 and is now obsolete along with the older PI 7, PI 7c and PI 7H interfaces.



#### CAUTION:

- 1) Check the PI 7-2 version as the switch information shown below is for pre-version 13 units only. The later version 13 PI 7-2 units have different switch functions.
- 2) All stylus tips must be re-qualified if 'mid-sensitivity' and 'auto-reset' are altered.

The DIL switches of the pre-version 13 PI 7-2 interface are on the rear panel, functions are shown below.

Switch number		Position	Function
1	SSR invert	UP	SSR closed when probe seated
		DOWN	SSR open when probe seated
2	Buzzer	UP	Buzzer OFF
		DOWN	Buzzer ON
3	Kinematic probe input	UP	Autojoint input only
		DOWN	PICS input enabled
4	Probe type	UP	Optimise for issue '01' (or later) probe
		DOWN	All probe types
5	STOP disable	UP	No response to PICS – STOP
		DOWN	Responds to PICS – STOP
6	HALT invert	UP	PICS – HALT output active HIGH
		DOWN	PICS – HALT output active LOW
7	HALT mode	UP	HALT generated internally
		DOWN	HALT asserted by PICS
8	Auto reset	RIGHT	Automatic reset disabled
		LEFT	Probe will reset after 2 seconds
9	Trigger sensitivity	RIGHT	Level 1 (high sensitivity)
		LEFT	Level 2 (mid sensitivity)

## 13.2 PI 7-2 probe interface, version 13 and later

### 13.3 Description

The version 13 and later PI 7-2 units are the current interface type for TP7M multiwire strain gauge probes. Used for conditioning the signal outputs of TP7M and standard touch-trigger probes, they provide PICS and SSR signal outputs. It supersedes the now obsolete pre-version 13 PI 7-2 and the older PI 7, PI 7c and PI 7H interfaces.



#### CAUTION:

- 1) Check the PI 7-2 version as the switch information shown below is for version 13 and later units. Earlier pre-version 13 PI 7-2 units have different switch functions.
- 2) All stylus tips must be re-qualified if 'mid-sensitivity' and 'auto-reset' are altered.

The DIL switches for version 13 and later PI 7-2 interfaces are shown below.

Switch number		Position	Function
1	SSR invert	UP	SSR closed when probe seated
		DOWN	SSR open when probe seated
2	Buzzer	UP	Buzzer OFF
		DOWN	Buzzer ON
3	Kinematic probe input	UP	Autojoint input only
		DOWN	PICS input enabled
4	Probe type	UP	Optimise for issue '01' (or later) probe
		DOWN	All probe types
5	STOP disable	UP	No response to PICS – STOP
		DOWN	Responds to PICS – STOP
6	HALT invert	UP	PICS – HALT output active HIGH
		DOWN	PICS – HALT output active LOW
7	HALT mode	UP	HALT generated internally
		DOWN	HALT asserted by PICS
8	Auto reset	UP	Probe will reset after 2 seconds
		DOWN	Automatic reset disabled
9	Trigger sensitivity	UP	Level 2 (mid sensitivity)
		DOWN	Level 1 (high sensitivity)
10	No function	-	Not used

## 13.4 PI 7-2 probe interface connections, all versions

### 13.4.1 PICS input

The PICS input signal connector is a 9-pin D-type socket with the pin numbers shown below:

Pin number	Description
1	STOP
2	Probe power off (PPOFF)
3	0 V
4	Reserved for Renishaw use
5	Probe input
6	HALT in
7	Probe damping (PDAMP)
8	LED OFF
9	Probe return 0 V
Body	Screen

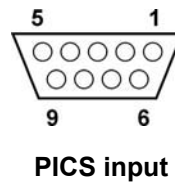

### 13.4.2 PICS output

The PICS output connector is a 9-pin D-type plug with the pin numbers shown below:

Pin number	Description
1	STOP
2	Probe power off (PPOFF)
3	0 V
4	Reserved for Renishaw use
5	SYNC (probe trigger)
6	HALT output
7	Probe damping (PDAMP)
8	LED OFF
9	-
Body	Screen

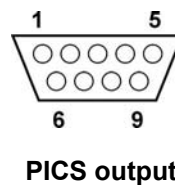

### 13.4.3 Probe input

The TP7M multiwire strain gauge probe input connector is a 15-pin high density D-type socket. The pin numbers are shown below:

Pin number	Description
1	Reference
2	Overall screen
3	2 wire probe signal / probe ident return
4	Uncommitted
5	Uncommitted
6	Uncommitted
7	Uncommitted
8	Probe identification
9	Co-axial screen
10	75 Ohm co-axial inner
11	Uncommitted
12	Uncommitted
13	2 wire probe signal
14	Not connected to probe
15	Not connected to probe

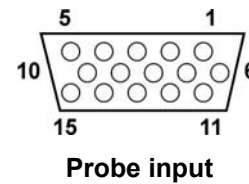

### 13.4.4 SSR output

The SSR output is a 5-pin DIN-type socket connector with the pin numbers shown below:

Pin number	Description
1	-
2	Screen
3	-
4	Probe status output
5	Probe status output

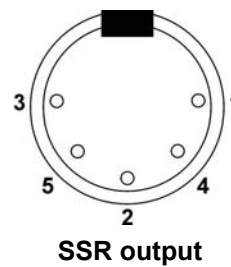

## 14 PI 7c and PI 7H version probe interfaces

### 14.1 Description

In addition to the obsolete pre-version 13 PI 7-2 and PI 7 interfaces, there were two custom product versions being PI 7c and PI 7H. The version 13 PI 7-2 unit is the upgrade replacement for these obsolete units.

### 14.2 PI 7c and PI 7H version probe interface switches

The table below details equivalent switch settings of the current version 13 PI 7-2, obsolete pre-version 13 PI 7-2, PI 7, PI 7c and PI 7H for upgrade purposes.

Function	PI 7-2 *	PI 7-2 #	PI 7	PI 7c	PI 7H
SSR invert	Sw1 UP DOWN	Sw1 UP DOWN	Sw2 UP DOWN	Sw2 UP DOWN	Sw2 UP DOWN
Buzzer off	Sw2	Sw2	'VOL' on rear panel	'VOL' on rear panel	'VOL' on rear panel
Kinematic probe input	Sw3 UP DOWN	Sw3 UP DOWN	Sw6 DOWN UP	Sw6 DOWN UP	Sw6 DOWN UP
Probe type	Sw4	Sw4	No function	No function	No function
STOP disable	Sw5 UP DOWN	Sw5 UP DOWN	Internal Sw3 on motherboard UP DOWN	Internal Sw3 on motherboard UP DOWN	Internal Sw3 on motherboard UP DOWN
HALT invert	Sw6 UP DOWN	Sw6 UP DOWN	No function	Internal Sw1 on LED board RIGHT LEFT	Internal Sw1 on LED board RIGHT LEFT
HALT mode	Sw7 UP DOWN	Sw7 UP DOWN	No function	No function	Internal Sw2 on LED board LEFT RIGHT
Auto reset	Sw8 DOWN	Sw8 RIGHT	Sw4/5 Sw4 DOWN Sw5 DOWN	Sw4/5 Sw4 DOWN Sw5 DOWN	Sw4/5 Sw4 DOWN Sw5 DOWN
	Sw8 UP	Sw8 LEFT	Sw4 UP Sw5 DOWN	Sw4 UP Sw5 DOWN	Sw4 UP Sw5 DOWN
Trigger sensitivity Level 2	Sw9 UP	Sw9 RIGHT	Sw3 DOWN	Sw3 DOWN	Sw3 DOWN
Level 1	DOWN	LEFT	UP	UP	UP
Grounding	Function deleted	Function deleted	Sw1	Sw1	Sw1

\* Version 13 and above.

# Version 12 and below.

**NOTE:** The PI 7c has internal switches on the LED board and the and main interface board. The red circular setting switch (numbered 1 to 9) on the LED board adjusts HALT signal sensitivity.



## 15 AC1 and AC2 counter cards

### 15.1 AC1 counter card

#### 15.1.1 Description

The AC1 analogue to digital counter card is a plug-in ISA card used with the SP600, SP600M 'XE' and SP600Q type probes to condition and convert the analogue probe signal output.

It has 1  $\mu\text{m}$  resolution.



#### ATTENTION:

The AC1 card contains static sensitive components.

Observe anti-static handling precautions, including the use of earth straps during handling and installation.

#### 15.1.2 AC1 card switches

The AC1 is an 8-bit ISA card default set to I/O base address  $0200_{\text{H}}$  used to convert the analogue signals to digital output. The base address can be altered using the SW1 switches below:

AC1 card I/O space base address				
Switch (SW1)				
PC function	Address	Way 1	Way 2	Way 3
Games adaptor	$0200_{\text{H}}$	Off	Off	Not used
PC expansion port	$0210_{\text{H}}$	On	Off	
Prototype adapter	$0300_{\text{H}}$	On	On	
Prototype adapter	$0310_{\text{H}}$	On	On	

## 15.2 AC2 counter card

### 15.2.1 Description

The AC2 analogue to digital counter card is a plug-in ISA card used with the SP600, SP600M 'XE' and SP600Q type probes to condition and convert the analogue probe signal output. It has 0.5 Micron resolution.



ELECTROSTATIC  
SENSITIVE

#### ATTENTION:

The AC2 counter card contains static sensitive components.

Observe anti-static handling precautions, including the use of earth straps during handling and installation.

**NOTE:** All 16 address bits on the PC expansion bus are decoded. Clashes are still possible if base addresses are below 0400<sub>H</sub> and match the lower 10 bits of AC2 addresses.

### 15.2.2 AC2 counter card SW1 switches

The AC2 is a 16-bit ISA counter card set to I/O base address 0200<sub>H</sub> and used to convert the analogue signals to digital output. The base address can be altered using the switches below:

AC2 card I/O space base address					
Switch (SW1)					
PC function	Address	Way 1	Way 2	Way 3	Way 4
Games adaptor	0200 <sub>H</sub>	Off	Off	Off	Off
PC expansion	0210 <sub>H</sub>	On	Off	Off	Off
Prototype	0280 <sub>H</sub>	Off	On	Off	Off
Prototype	0300 <sub>H</sub>	On	On	Off	Off
Not defined	0310 <sub>H</sub>	Off	Off	On	Off
Not defined	0320 <sub>H</sub>	On	Off	On	Off
Not defined	0340 <sub>H</sub>	Off	On	On	Off
Not defined	0350 <sub>H</sub>	On	On	On	Off
Not defined	0390 <sub>H</sub>	Off	Off	Off	On
Not defined	03A0 <sub>H</sub>	On	Off	Off	On
Not defined	0480 <sub>H</sub>	Off	On	Off	On
Not defined	0520 <sub>H</sub>	On	On	Off	On
Not defined	0540 <sub>H</sub>	Off	Off	On	On
Not defined	0550 <sub>H</sub>	On	Off	On	On
Not defined	0590 <sub>H</sub>	Off	On	On	On
Not defined	05A0 <sub>H</sub>	On	On	On	On

### 15.2.3 AC2 counter card SW2 switches



**ATTENTION:**

The AC2 counter card contains static sensitive components.

Observe anti-static handling precautions, including the use of earth straps during handling and installation.



**CAUTION:** The SW2 way 2 switch **MUST** be set correctly for ISA bus operation, otherwise damage may occur to the AC2 card or the host PC.

#### Switches

The AC2 is a 16-bit ISA card default set to I/O base address 0200<sub>H</sub> used to convert the analogue signals to digital output.

Operation of 8 or 16 bit data width and the Delta Tau bus can be set using the SW2 switches below:

AC2 card SW2 switch settings				
Switch setting	Way 1	Way 2	Way 3	Way 4
		8/16 – bit	AUX_SW1	Reserved
OFF	16 - bit	ISA bus	Future use	Future use
ON	8 – bit	Delta Tau bus		

## 15.3 AC1 and AC2 counter card connectors

### 15.3.1 SP600 multiwire probe signal input

The AC1 and AC2 counter cards both have a 15-pin D-type probe input socket with pin numbers shown below:

Pin number	Description
1	+5 V power output
2	High impedance (not connected)
3	0 V power (power return)
4	Y axis signal input
5	Z axis signal input
6	+12 V power output
7	-12 V power output
8	Probe identification (signal input)
9	High impedance (not connected)
10	High impedance (not connected)
11	X axis (signal input) – see note below
12	0 V reference (signal input)
13	High impedance (not connected)
14	Head LED anode (signal output)
15	Head LED cathode (signal output)
Shell	Screen (protective ground)

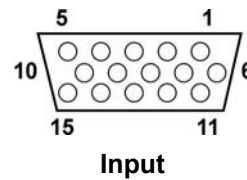

**NOTE:** Isolated to >100 K $\Omega$  when the probe is disconnected or not recognised as SP600.

### 15.3.2 PICS signal input

The AC1 and AC2 counter cards use a 9-pin D-type socket for the PICS signal input with the pin numbers shown below:

Pin number	Description
1	STOP
2	Probe power off (PPOFF)
3	0 V
4	Reserved for Renishaw use
5	Probe signal
6	+5 V
7	Probe damping (PDAMP)
8	LED OFF
9	Probe
Body	Screen

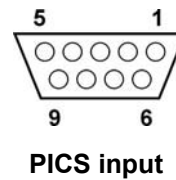

## 16 AC3 counter card

### 16.1 Description

The AC3 analogue to digital counter card is a plug-in ISA card for use with the SP25M probe to condition the probe signal output. It has 0.5  $\mu\text{m}$  resolution.



#### ATTENTION:

The AC3 counter card contains static sensitive components.

Observe anti-static handling precautions, including the use of earth straps during handling and installation.

**NOTE:** All 16 address bits on the PC expansion bus are decoded. Clashes are still possible if base addresses are below 0400<sub>H</sub> and match the lower 10 bits of AC2 addresses.

### 16.2 AC3 counter card SW1 switches

The AC3 is a 16-bit ISA card default set to I/O base address 0200<sub>H</sub> used to convert the analogue signals to digital output. The base address can be altered using the switches below:

AC3 card I/O space base address					
Switch (SW1)					
PC function	Address	Way 1	Way 2	Way 3	Way 4
Games adaptor	0200 <sub>H</sub>	Off	Off	Off	Off
PC expansion	0210 <sub>H</sub>	On	Off	Off	Off
Prototype	0280 <sub>H</sub>	Off	On	Off	Off
Prototype	0300 <sub>H</sub>	On	On	Off	Off
Not defined	0310 <sub>H</sub>	Off	Off	On	Off
Not defined	0320 <sub>H</sub>	On	Off	On	Off
Not defined	0340 <sub>H</sub>	Off	On	On	Off
Not defined	0350 <sub>H</sub>	On	On	On	Off
Not defined	0390 <sub>H</sub>	Off	Off	Off	On
Not defined	03A0 <sub>H</sub>	On	Off	Off	On
Not defined	0480 <sub>H</sub>	Off	On	Off	On
Not defined	0520 <sub>H</sub>	On	On	Off	On
Not defined	0540 <sub>H</sub>	Off	Off	On	On
Not defined	0550 <sub>H</sub>	On	Off	On	On
Not defined	0590 <sub>H</sub>	Off	On	On	On
Not defined	05A0 <sub>H</sub>	On	On	On	On

## 16.3 AC3 counter card SW2 switches



### ATTENTION:

The AC3 counter card contains static sensitive components.

Observe anti-static handling precautions, including the use of earth straps during handling and installation.



**CAUTION:** The SW2 way 2 switch **MUST** be set correctly for ISA bus operation, otherwise damage may be caused either to the AC3 card or the host PC.

### Switches

The AC3 is a 16-bit ISA counter card default set to I/O base address 0200<sub>H</sub> used to convert the analogue signals to digital output.

Operation of 8 or 16 bit data width and the Delta Tau bus can be set using the SW2 switches below:

AC3 card SW2 switch settings				
Switch setting	Way 1	Way 2	Way 3	Way 4
	8/16 – bit	BUS select	Connect in SP600 over-travel unit	Connect in SP25M over- range signal
OFF	16 - bit	ISA BUS	OFF must be selected	
ON	8 – bit	Delta Tau bus		ON must be selected

## 16.4 AC3 counter card connectors

### 16.4.1 SP25M multiwire probe signal input

The AC3 counter card has a 15-pin D-type probe input socket connector with the pin numbers shown below:

Pin number	Description
1	+5 V power output – see note below
2	High impedance (not connected)
3	0 V power (power return)
4	q axis signal input – see note below
5	r axis signal input – see note below
6	+12 V power output – see note below
7	-12 V power output – see note below
8	Probe identification (signal input)
9	2 wire probe signal (high impedance)
10	Over-range (signal input)
11	q axis signal input – see note below
12	0 V reference (signal input)
13	High impedance (not connected)
14	Head LED anode (signal output)
15	Head LED cathode (signal output)
Shell	Screen (protective ground)

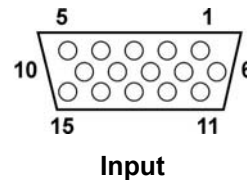

**NOTE:** Isolated to >100 K $\Omega$  when the probe is disconnected or not recognised as SP600.



### 16.4.2 PICS signal input

The AC 3 counter card has a 26 pin 'D' type PICS signal input plug connector with pin numbers shown below:

Pin number	Description
1	STOP (OUT), signal output – see note below
2	PPOFF (OUT), signal input – see note below
3	0 V (OUT) , power return – see note below
4	+5 V (OUT), power output
5	SYNC (OUT), signal output
6	HALT (OUT), signal output
7	PDAMP (OUT), signal input – see note below
8	LED OFF (OUT), signal output – see note below
9	READ (OUT), signal input
10	PROBE RETURN, high impedance
11	Not connected, high impedance
12	Not connected, high impedance
13	Not connected, high impedance
14	Not connected, high impedance
15	Not connected, high impedance
16	Not connected, high impedance
17	Reserved for future use, power return
18	Reserved for future use, signal input
19	LED OFF (IN), signal output – see note below
20	PDAMP (IN), signal input – see note below
21	150 $\Omega$ pull up resistor, signal input
22	PROBE SIGNAL, high impedance
23	LED anode (IN), signal output
24	0 V (IN), power return – see note below
25	PPOFF (IN), signal input – see note below
26	STOP (IN), signal output – see note below
Shell	Screen, protective ground

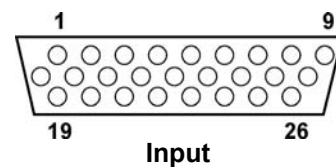

**NOTE:** Signals connected from the PICS IN to PICS OUT connector.

## 17 PI 800 probe interface

### 17.1 Description

The now obsolete PI 800 interface was used to condition the complex piezo, strain and kinematic signals from the also obsolete TP800 ultra-high precision probe.



**CAUTION:** TP800 probes must only be used with the PI 800 interfaces. The later TP800-2 probes and PI 800-2 interfaces are NOT compatible with them.

### 17.2 PI 800 probe interface switches

The PI 800 switch settings and their functions are shown below:

Switch number		Position	Function
1	SHOCK	Up OFF (recommended)	Enables SHOCK signal to generate SYNC
		Down ON	Disables SHOCK signal
2	STRAIN	Up OFF (recommended)	Enables STRAIN signal to generate SYNC
		Down ON	Disables STRAIN signal
3	KINEMATIC	Up OFF (recommended)	Enables KINEMATIC to generate SYNC
		Down ON	Disables KINEMATIC signal
4	PPOFF Delay	Up OFF (recommended)	5 ms delay enabled
		Down ON	5 ms delay disabled
5	PDAMP mode	Up OFF (recommended)	Disables the shock generated by SYNC signals when PDAMP is pulled low
		Down ON	Prevents SHOCK and STRAIN generated SYNC signals when PDAMP is pulled low
6	Cable break	Up OFF (recommended)	Disconnects 150 $\Omega$ resistor in the interface detection selector (for use with multiple probe installations only)
		Down ON	Connects 150 $\Omega$ resistor in the interface detection selector (for use with single interface installations only)

## 17.3 PI 800 probe interface, initial integration

**NOTE:** This page shows connections for INITIAL integration of the obsolete TP800 probe system.

### 17.3.1 PICS signal output

The PICS output connector is a 9-pin D-type plug with pin numbers for **INITIAL** integration shown below:

Pin number	Description
3	0 V
4	ERROR
5	SYNC (probe trigger)
6	HALT output
Body	SCREEN

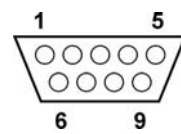

**PICS output**

### 17.3.2 Additional signal output

The additional output is a 5-pin DIN-type socket with pin numbers shown below:

Pin number	Description
2	Screen
4	STRAIN

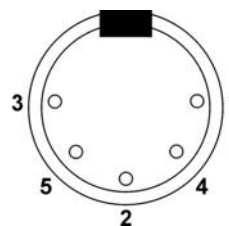

**Output**

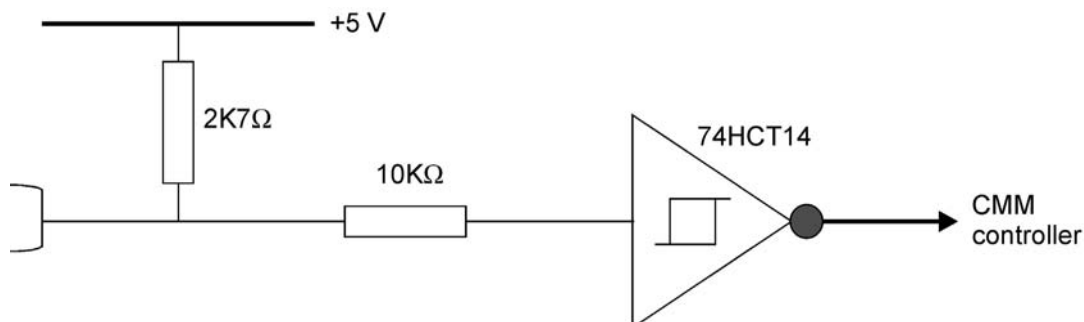

**NOTE:** When these signals, the 0 V and screen have been connected, the probe system is operational at full precision specification.

## 17.4 PI 800 probe interface, AFTER initial integration

**NOTE:** This page shows the connections for full operation of the obsolete PI 800 and TP800 system done AFTER the initial integration is complete.

### 17.4.1 PICS signal output

The PICS output connector is a 9-pin D-type plug with the pin numbers **AFTER** initial integration are shown below:

Pin number	Description
1	STOP
2	PPOFF
3	0 V
4	ERROR
5	SYNC (probe trigger)
6	HALT output
7	Probe damping (PDAMP)
8	Not used
9	Not used
Body	SCREEN

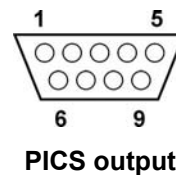

### 17.4.2 Additional signal output

The additional output is a 5-pin DIN-type socket with the pin numbers shown below:

Pin number	Description
1	PROBE PRESENT
2	Screen
3	SHOCK CONTROL
4	STRAIN
5	ERROR

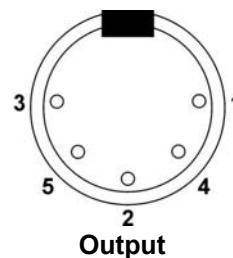

**NOTE:** Pin 5 of this additional signal output connector duplicates pin 4 of the PICS output connector. Either may be used to connect the ERROR signal.

### 17.4.3 Remaining operating signal terminations after initial setup

PROBE PRESENT is an input signal to the CMM and requires a resistor termination and receiver conforming to TTL levels. This is the same circuit as SYNC, etc.

STOP is pulled low when mains power is switched off. The use of a 150 Ohm resistor ('Rt' in the diagram below) pulls the line low if the cable between the CMM and the PI 800 is disconnected.

The CMM controller can set STOP to force an emergency stop of the CMM and probing system.

**NOTE:** All 39 Ohm resistors used in the circuits below should be 1 Watt devices.

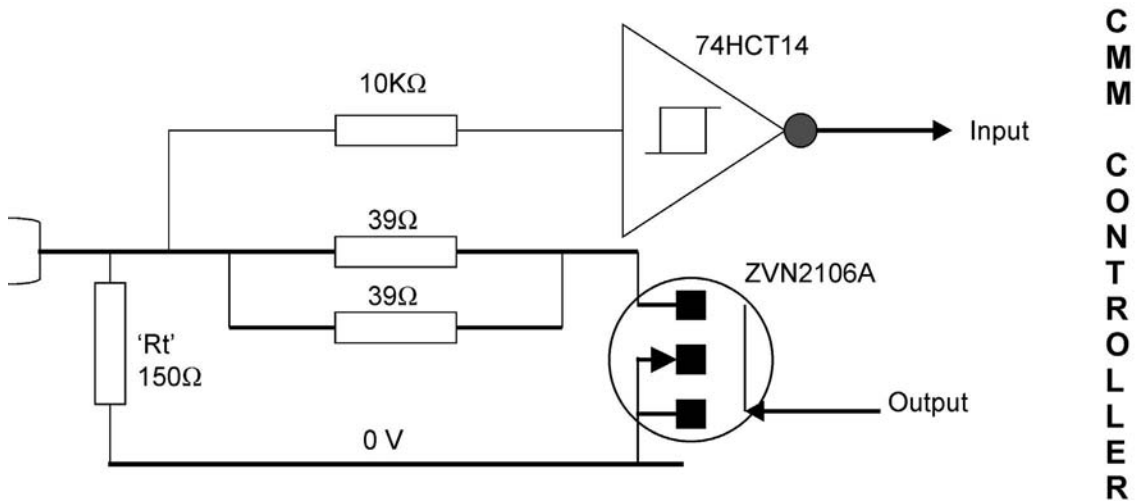

### 17.4.4 PPOFF shock control

The CMM output signals must be driven by an open collector (OCT) device with appropriate resistor terminations. See diagram below:

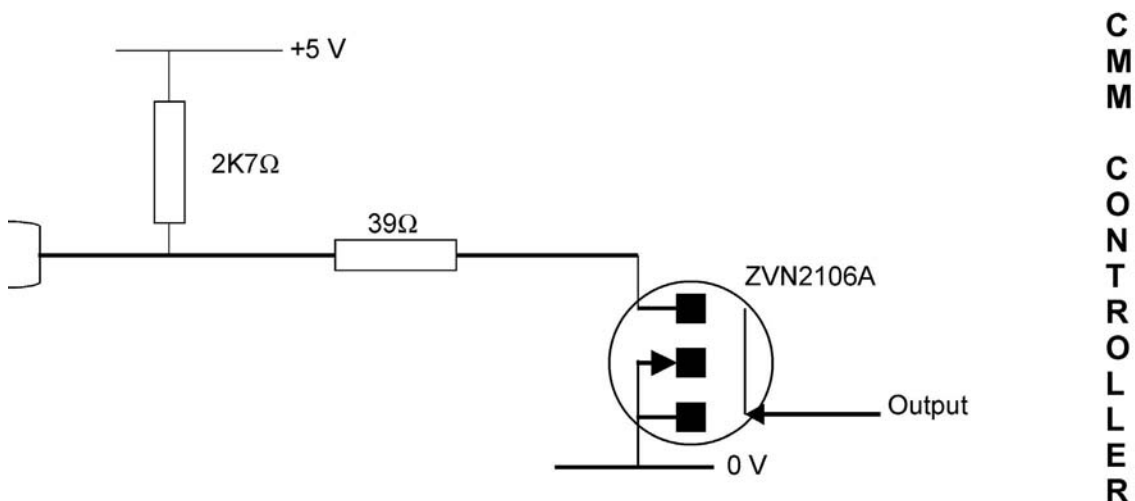

## 18 PI 800-2 probe interface

### 18.1 Description

The PI 800-2 interface is used to condition the complex piezo, strain and kinematic signals from the TP800-2 ultra-high precision probe.

**This system replaced the obsolescent PI 800 and TP800.**



**CAUTION:** TP800-2 probes must only be used with the PI 800-2 interfaces. The earlier TP800 probes and PI 800 interfaces are NOT compatible with them.

### 18.2 PI 800-2 probe interface switches

The switch settings and their functions are shown below:

Switch number		Position	Function
1	SHOCK	Up OFF (recommended)	Enables SHOCK signal to generate SYNC
		Down ON	Disables SHOCK signal
2	STRAIN	Up OFF (recommended)	Enables STRAIN signal to generate SYNC
		Down ON	Disables STRAIN signal
3	KINEMATIC	Up OFF (recommended)	Enables KINEMATIC to generate SYNC
		Down ON	Disables KINEMATIC signal
4	PPOFF Delay	Up OFF (recommended)	5 ms delay enabled
		Down ON	5 ms delay disabled
5	PDAMP mode	Up OFF (recommended)	Disables the shock generated by SYNC signals when PDAMP is pulled low
		Down ON	Prevents SHOCK and STRAIN generated SYNC signals when PDAMP is pulled low
6	Cable break	Up OFF (recommended)	Disconnects 150 $\Omega$ resistor in the interface detection selector (for use with multiple probe installations only)
		Down ON	Connects 150 $\Omega$ resistor in the interface detection selector (for use with single interface installations only)

## 18.3 PI 800-2 probe interface, initial integration

**NOTE:** This page shows connections for INITIAL integration of the TP800-2 probe system.

### 18.3.1 PICS signal output

The PICS output connector is a 9-pin D-type plug with pin numbers for **initial** integration are shown below:

Pin number	Description
3	0 V
4	ERROR
5	SYNC (probe trigger)
6	HALT output
Body	SCREEN

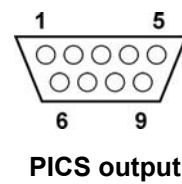

### 18.3.2 Additional signal output

The additional output is a 5-pin DIN-type socket with the pin numbers shown below:

Pin number	Description
2	Screen
4	STRAIN

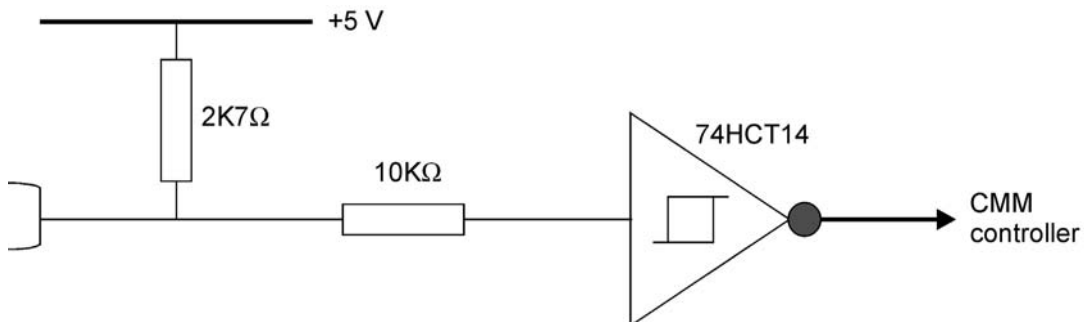
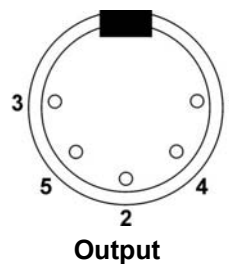

**NOTE:** When these signals, the 0 V and screen have been connected, the probe system is operational at full precision specification.

## 18.4 PI 800-2 probe interface, AFTER initial integration

**NOTE:** This page shows the connections for full operation of the PI 800-2 and TP800-2 system done AFTER the initial integration is complete.

### 18.4.1 PICS signal output

The PICS output connector is a 9-pin D-type plug with pin numbers for **after** initial integration shown below:

Pin number	Description
1	STOP
2	PPOFF
3	0 V
4	ERROR
5	SYNC (probe trigger)
6	HALT output
7	Probe damping (PDAMP)
8	Not used
9	Not used
Body	SCREEN

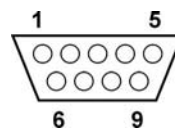

**PICS output**

### 18.4.2 Additional signal output

The additional output is a 5-pin DIN-type socket with the pin numbers shown below:

Pin number	Description
1	PROBE PRESENT
2	Screen
3	SHOCK CONTROL
4	STRAIN
5	ERROR

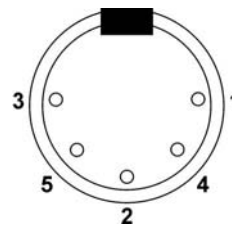

**Output**

**NOTE:** Pin 5 of this additional signal output connector duplicates pin 4 of the PICS output connector. Either may be used to connect the ERROR signal.



### 18.4.3 Remaining operating signal terminations AFTER initial integration

PROBE PRESENT is an input signal to the CMM and requires a resistor termination and receiver conforming to TTL levels. This is the same circuit as SYNC, etc.

STOP is pulled low when mains power is switched off. The use of a 150 Ohm resistor ('Rt' in the diagram below) pulls the line low if the cable between the CMM and the PI 800-2 is disconnected.

The CMM controller can set STOP to force an emergency stop of the CMM and probing system. See the diagram below.

**NOTE:** All 39 Ohm resistors used in the circuits below should be 1 Watt devices.

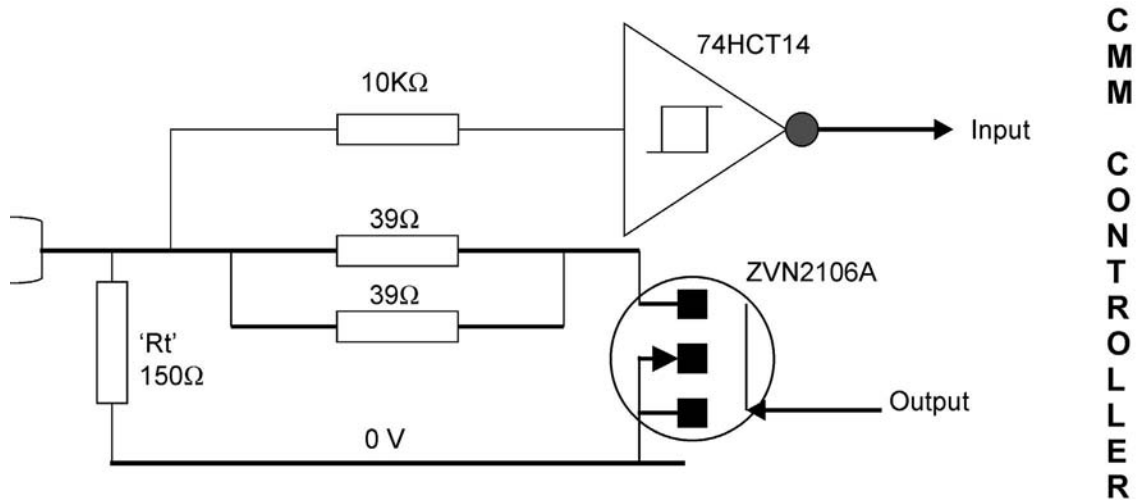

### 18.4.4 PPOFF shock control

The CMM output signals should be driven by an open collector (OCT) device with appropriate resistor terminations. See the diagram below:

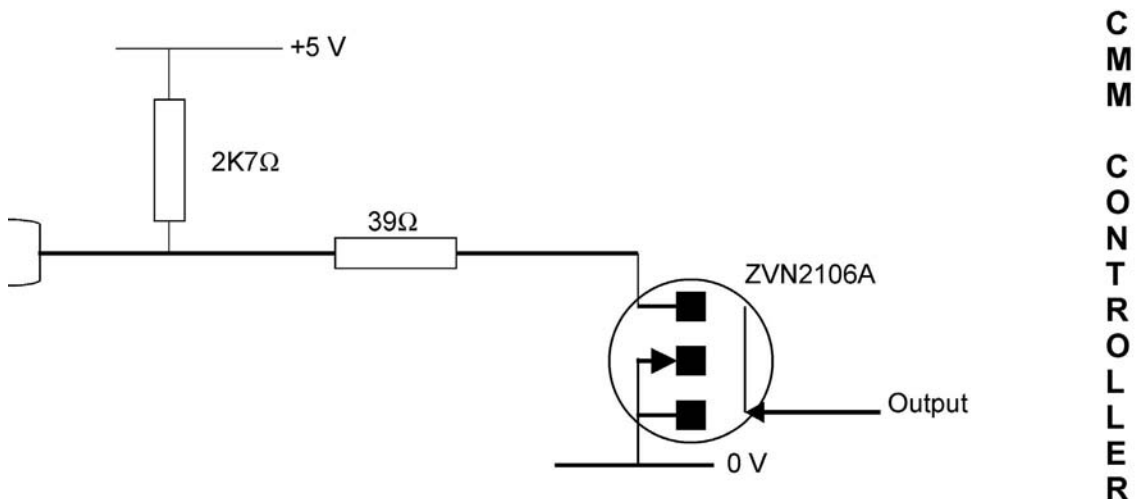

## 19 IS 1 interface selector

### 19.1 Description

The IS 1 interface selector was used on CMMs where selection between multiple probe systems was required. It recognises and selects the correct probe and interface combination using internal plug-in program modules to sense discrete resistance values in the probe.

The IS 1 unit is now obsolete and has been replaced by the IS1-2.

### 19.2 IS 1 program modules and outputs



**WARNING:** Ensure power is removed from the IS 1 interface selector before gaining access to the internal module holders.

The program module positions and corresponding output socket numbers are shown in the table and diagram below:

Program module	IS 1 output socket numbers	
<b>A</b>	4	TP800 must be connected to socket 4 only
<b>B</b>	3	
<b>C</b>	1	TP2, TP6, TP20, TP220 and TP7M probe systems must use socket 1 only
<b>D</b>	2	

**Program module positions:**

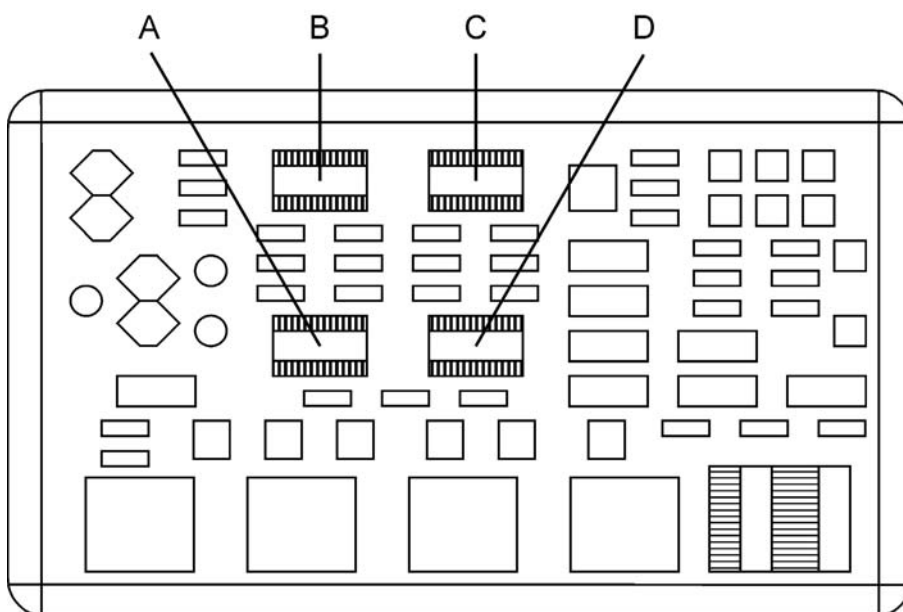

Diagram of IS 1 interface selector with cover off

## 19.3 IS 1 connectors

### 19.3.1 IS 1 power input

The CL40 was the power supply unit providing 15 V DC to the IS1 interface selector via a 5-pin DIN-type socket. The pin numbers are shown below:

Pin number	Description
1	0 V
2	0 V
3	+5 V
4	-15 V (not used by the IS 1)
5	+15 V

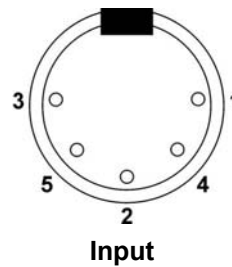

### 19.3.2 IS 1 probe input

The IS 1 probe input is a 15-pin high-density D-socket with the pin numbers shown below:

Pin number	Description
1	General
2	Overall screen
3	2 wire probe signal / general
4	General
5	General
6	General
7	General
8	Probe identification
9	Co-axial screen
10	Co-axial inner
11	General
12	General
13	2 wire probe signal / general
14	LED anode
15	LED cathode

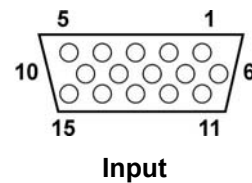

### 19.3.3 IS 1 channel output

The four IS 1 channel output connectors are all 15-pin high-density D-plugs and share the same pin numbers as the probe input socket connector above.

### 19.3.4 IS 1 PICS output signal

The IS 1 PICS output signal connector is a 9-pin D-type plug with the pin numbers shown below:

Pin number	Description
1	STOP
2	-
3	0 V reference
4	-
5	-
6	-
7	-
8	-
9	-
Body	SCREEN

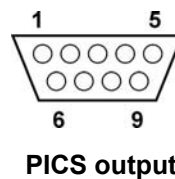

**NOTE:** Because the IS 1 interface selector is not an actual interface the only PICS connection required is ESTOP (emergency stop).

### 19.3.5 IS1 channel output indicator

The IS 1 channel output indicator connector is a 6-pin DIN-type socket and is used to show which electrical output is selected. Output levels conform to PICS signal specifications, i.e. outputs 1 to 4 are normally high (+5 V) and are pulled low when the appropriate interface is selected.

Pin numbers and functions are shown below:

Pin number	Description
1	Output 1
2	Output 2
3	Output 3
4	Output 4
5	0 V reference
6	Not connected

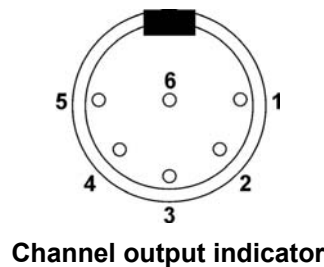

The outputs are open collector devices with the following characteristics:

ON      $V_{ce} = 0.4$  maximum @  $I_c = 15$  mA minimum.

OFF    Leakage current  $\leq 0.25$  mA maximum @  $V_{ce} = 5.25$  V.

## 20 IS 1-2 interface selector

### 20.1 Description

The IS 1-2 interface selector is the current unit used on CMMs where selection between multiple probe systems is required. It enables recognition and selection of the correct probe and interface combination using internal plug-in programming modules to sense discrete resistance values in the probe.

The IS 1-2 replaces the obsolete IS 1.

### 20.2 IS 1-2 channel outputs



**WARNING:** Ensure power is removed from the IS1-2 interface selector before gaining access to the internal module holders.

The holders for the plug in programming modules are numbered to correspond to the output 'channel' number. These numbers are marked on the printed circuit board and these positions, the channel socket and corresponding output connector numbers are detailed below:

IS 1-2 channel output socket	
Channel 1	Configured for TP2, TP6, TP20, TP200 and TP7M
Channel 2	Configured for SP600M
Channel 3	Configured for OTP6M or SP80
Channel 4	Configured for TP800-2 or SP25M

Program module positions:

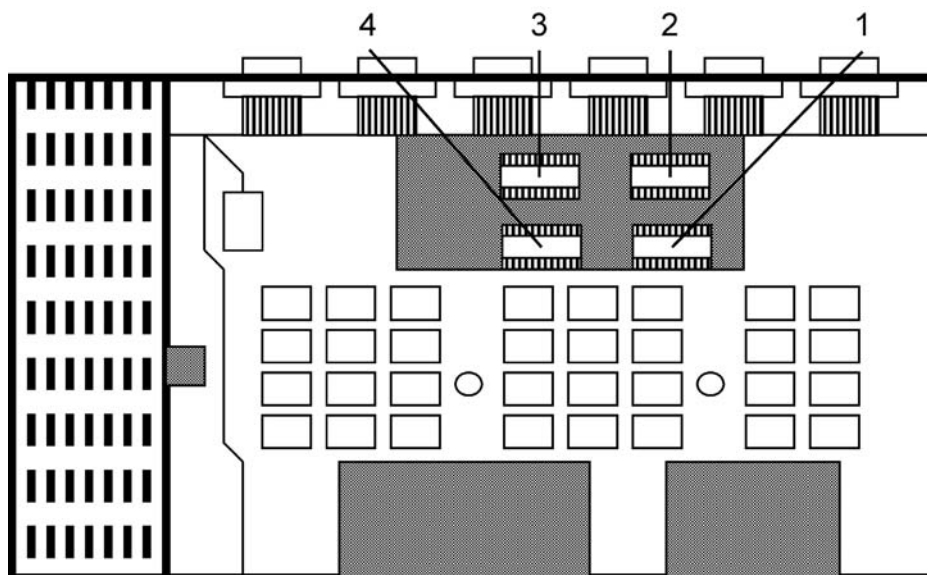

Diagram of IS 1-2 interface selector with cover off

## 20.3 IS 1-2 connectors

### 20.3.1 IS 1-2 probe input

The IS1-2 probe input is a 15-pin high density D-socket with the pin numbers shown below:

Pin number	Description
1	General
2	Overall screen
3	2 wire probe signal / general
4	General
5	General
6	General
7	General
8	Probe identification
9	Co-axial screen
10	Co-axial inner
11	General
12	General
13	2 wire probe signal / general
14	LED anode
15	LED cathode

} PH6M

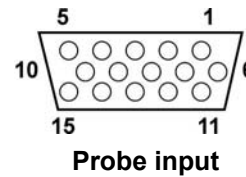

### 20.3.2 IS1-2 channel output

The four channel output connectors are 15-pin high density D-type plugs and use the same pin numbers as the probe input socket connector shown above.

### 20.3.3 IS1-2 PICS output signal

The IS1-2 PICS output signal connector is a 9-pin D-type plug with the pin numbers shown below:

Pin number	Description
1	STOP
2	-
3	0 V reference
4	-
5	-
6	-
7	-
8	-
9	-
Body	SCREEN

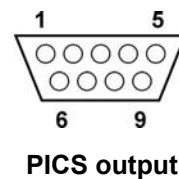

**NOTE:** Because the IS1-2 interface selector is not an actual interface the only PICS connection that is activated is STOP (emergency stop).

### 20.3.4 IS1-2 channel output indicator

The IS1-2 channel output indicator connector is a 6-pin DIN-type socket and is used to show which electrical output is selected. Output levels conform to PICS signal specifications, i.e. outputs 1 to 4 are normally high (+5V) and are pulled low when the appropriate interface is selected.

Pin numbers and functions are shown below:

Pin number	Description
1	Channel 1 selected
2	Channel 2 selected
3	Channel 3 selected
4	Channel 4 selected
5	0 V reference
6	Not connected

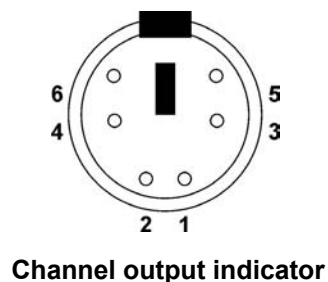

These outputs are open collector devices with 3K3 Ohm pull-up resistors and the following characteristics:

ON     0.4 V maximum @  $I_c = 15 \text{ mA}$

OFF    Leakage current  $\leq 0.25 \text{ mA}$  maximum @  $V_{ce} = 5.25 \text{ V}$

## 20.4 IS1-2 installation rules

- TP2, TP6, TP20 and TP200 probe signals must always be connected to channel 1. This is independent of the programming module fitted (if any).
- If no probes are connected to the IS1-2 input, the probe signal from channel 1 will emulate a triggered conventional touch probe.
- If TP200 is part of the system, a PI 200 must be connected to the IS1-2 channel 1.
- For TP2, TP6 and TP20 probes a suitable interface (such as PI 4-2) must be fitted to the IS1-2 channel 1.
- When a TP800-2 system is used with IS1-2 the PI 800-2 must be connected to channel 4.

## 20.5 IS1-2 programming modules

The following modules and identification resistance values are available:

Part number	Probe	Resistance value
A-1327-0550-01	TP7M	2K
A-1327-0620-01	SP600M	30K
A-1327-0630-01	OTP6M	3K7
A-1327-0650-01	SP25M	9K375
A-1327-0680-01	SP80	2K7



## 21 MIH–SI serial interface

### 21.1 Description

The MIH-SI is a communication interface for the custom product MIH-S manual indexable head. It uses Renishaw basic command set to communicate with the CMM PC through the RS232 serial link. As it is not a probe interface, a separate PI 4-2 or equivalent unit must be used for this purpose. A proprietary power supply is connected to the circular low voltage +24 V DC input socket.

### 21.2 MIH-SI switches

#### 21.2.1 MIH-SI switches

The RS232 communications protocol options are set using the eight internal switches in the MIH-SI, accessed by removing the top cover.

Switch	Baud rate					
	300	600	1200	2400	4800	9600
1	ON	OFF	ON	OFF	ON	OFF
2	ON	ON	OFF	OFF	ON	ON
3	ON	ON	ON	ON	OFF	OFF
Switch	ON (disable)			OFF (enable)		
4 and 5	Not defined			Not defined		
6	1 stop bit			2 stop bits		
7	No CTS (clear to send) protocol			CTS (clear to send) protocol		
8	No LF (line feed) protocol			LF (line feed) protocol		

Serial data transmission is in the following format:

1 start bit

7 data bits

1 or 2 stop bits (set using switch 7)

Even parity

---

**NOTE:** The MIH-SI default baud rate setting is 9600, 1 stop bit, no Clear To Send (CTS), no Line Feed (LF) and with the Renishaw basic command set for communication.

---

## 21.3 MIH-SI connectors

### 21.3.1 Inlet power

The MIH-SI is powered by +24 V via a round low voltage plug-in connector.

### 21.3.2 MIH-SI RS232 communication

The MIH-SI RS232 communications connector is a 9-pin D-type socket, the pin numbers are shown below:

Pin number	Description
1	-
2	TXD (transmitted data)
3	RXD (received data)
4	DTR (data transmit ready)
5	0 V ground
6	-
7	RTS (ready to send)
8	CTS (clear to send)
9	-

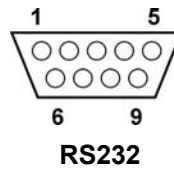

### 21.3.3 MIH-SI probe head connector

The MIH-SI probe head connector is a 15-pin high density D-type socket and the pin numbers are shown below:

Pin number	Description
1	+ Supply
2	HD_CLK /
3	HD_CLK
4	HD_DATA
5	HD_DATA /
6	Ground
7	LED cathode
8	-
9	Probe
10	Ground
11	-
12	LED anode
13	-
14	-
15	-

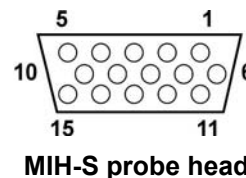

### 21.3.4 MIH-SI probe interface connector

The MIH-SI does not condition probe signals, therefore connection for a separate probe interface is provided by a 15-pin high density D-type socket. The pin numbers are shown below:

Pin number	Description
1	-
2	-
3	-
4	-
5	-
6	-
7	LED cathode
8	-
9	Probe
10	Ground
11	-
12	LED anode
13	-
14	-
15	-

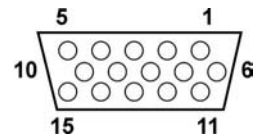

**Interface connector**

## 22 IU80 interpolator unit for SP80

### 22.1 Description

The IU80 is used to condition the SP80 scanning probe signal into an RS232 differential quadrature scale signal and is required where a UCC controller is not being used. The IU80 sends these signals via a PL158 cable to a separate CC6 counter card which resides in the CMM PC or controller base unit.

### 22.2 IU80 switches

#### 22.2.1 IU80 reset switch

The reset switch is located on the front panel of the IU80, if an error condition does occur this switch can be pressed to clear the error and reset the probe.

### 22.3 IU80 connectors

#### 22.3.1 IU80 probe input

The IU80 probe input connector is a 15-pin D-type socket. Signal functions and pin numbers are shown below:

Pin number	Description
1	Cos Y
3	Cos Z
4	0 V
5	PROBE PRESENT
6	GREEN LED ON
7	Sin Z
8	V ref
10	RED LED ON
11	Cos X
12	Sin X
14	Sin Y
15	+9 V to +18 V
Body	Screen

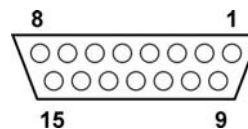

IU80 probe input

**22.3.2 IU80 signal output and CC6 card input**

The IU80 output connector is a 26-pin D-type plug and the CC6 card input connector is a 26-pin D-type socket. Signal descriptions and pin numbers are as follows:

IU80 output pin number	Signal	CC6 card input pin number
1	X axis log A	1
2	Not connected	-
3	IU80 RESET	9
4	IU80 ERROR	4
5	Not connected	-
6	Z axis log B	6
7	Not connected	-
8	PROBE PRESENT	2
9	GREEN LED OFF	7
10	RED LED ON	8
11	X axis log A	11
12	X axis log B	12
13	X axis log B	13
14	Y axis log A	14
15	Y axis log A	15
16	Y axis log B	16
17	Y axis log B	17

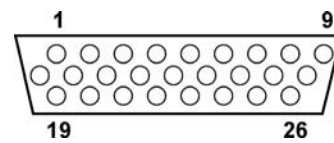

**IU80 output input**

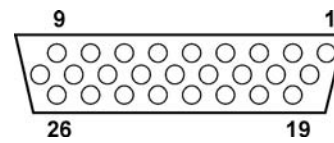

**CC6 card input connector**

**CAUTION:** When installing the CC6 ensure that the DLL switch is set as shown below. Damage may occur if incorrectly set.

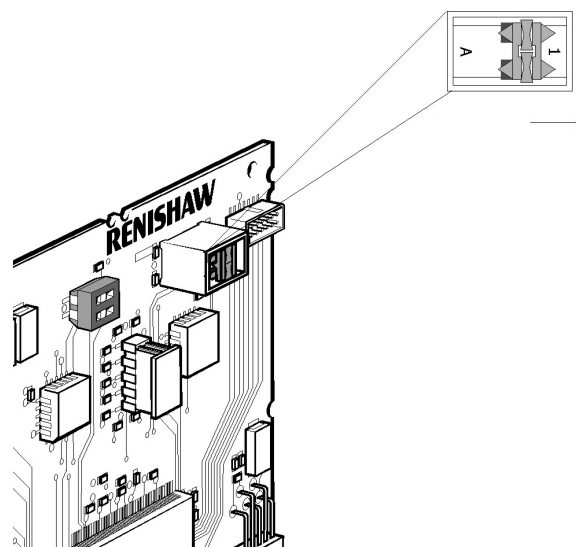

**CC6 counter card**

## 22.4 Connecting IU80 to an OEM card

The IU80 can also be connected directly to the CMM controller using an unterminated PL156 type cable. Pin numbers, signals and other details are shown below:

IU80 output pin number	Signal	Electrical characteristics	Wire colour
1	X axis log A	EIA-422A	Red
2	Not connected	-	-
3	IU80 RESET	TTL	White/blue
4	IU80 ERROR	TTL	Blue
5	Not connected	-	-
6	Z axis log B	EIA-422A	Green
7	Not connected	-	-
8	PROBE PRESENT	TTL	Yellow/blue
9	GREEN LED OFF	TTL	Yellow
10	RED LED ON	TTL	White
11	X axis log A	EIA-422A	Black
12	X axis log B	EIA-422A	Brown
13	X axis log B	EIA-422A	Violet
14	Y axis log A	EIA-422A	Orange
15	Y axis log A	EIA-422A	Pink
16	Y axis log B	EIA-422A	Turquoise
17	Y axis log B	EIA-422A	Grey
18	Not connected	-	-
19	Not connected	-	-
20	Z axis log A	EIA-422A	Red/blue
21	Z axis log A	EIA-422A	Green/red
22	Z axis log B	EIA-422A	Yellow/red
23	+9 V to +18 V	300 mA max	White/red
24	+5 V	1 A max	Red/black
25	0 V	-	Red/brown
26	Not connected	-	-
SHELL	Screen	-	Screen

## 23 PHC9 Mk2 controllers

### 23.1 Description

The PHC9 Mk2 was the original probe head controller for PH9 and PH9A motorised probe head systems. Two communication types were available for either RS232 serial or IEEE-488 parallel communication to and from the CMM PC or controller. They are recognisable by aluminium front panels with black Renishaw product labelling on it. Separate probe interfaces were required for probe signal conditioning.

**The PH9 systems are obsolete and should be replaced or upgraded by PH10 systems.**



**WARNING:** Always disconnect PHC9 Mk2 controller mains power before carrying out servicing activities, including communication switch selection.

### 23.2 PHC9 Mk RS232 version controller switches

The RS232 serial communication version PHC9 Mk2 controller is clearly marked by a white 'RS232' label on the lower left rear of the unit casing. Four DIL switches concealed under the bolt on PSU9 power supply are used to set the Baud rate. These switch settings are detailed below.

		Baud rate							
Switch		110	300	600	1200	2400	4800	9600	19200
Brown	1	ON	ON	ON	ON	OFF	OFF	OFF	OFF
Red	2	ON	ON	OFF	OFF	ON	ON	OFF	OFF
Orange	3	ON	OFF	ON	OFF	ON	OFF	ON	OFF

**NOTE:** Switch functions are ON = UP and OFF = DOWN

Some CMM's use a head present indication that is enabled by an 'SW 3' switch or wire link on the PHC9 Mk2 RS232 version controller board. Access to this is obtained by removing the PSU9 power supply and then separating the PHC9 Mk2 controller casing.

The SW3 switch or wire link is located on the top, right, rear face of the controller board.



**CAUTION:** When refitting the PSU9 power supply, ensure that the voltage selector switch is set to the correct value as failure to do so will damage the controller.

### 23.3 PHC9 Mk2 IEEE-488 version controller switches

The IEEE-488 parallel communications version PHC9 Mk2 controller is clearly identified by DIL switches and a white 'IEEE-488' label located on the lower left rear of the unit casing.

These DIL switches are used to set the parallel poll address and are detailed below:



**WARNING:** Always disconnect mains power to the PHC9 Mk2 controller before carrying out servicing actions or altering switch settings.

Switch	Binary code and switch colour		
1	1	Brown (least significant)	} Address (binary code)
2	2	Red	
3	4	Orange	
4	8	Yellow	
5	16	Green	
6	1	Blue (least significant)	} Parallel poll (binary plus-one code)
7	2	Violet	
8	4	Grey	

The IEEE parallel poll DIL switches on the back of the controller are inverted so that they read as UP for OFF and DOWN for ON when configuring them.

On both communication types of PHC9 Mk2 controller the brown DIL switch under the round SSR output connector can be set to ON (right) for 5-pin DIN operation or OFF (left) for 7-pin DIN operation.



**CAUTION:** When refitting the PSU9 power supply, ensure that the voltage selector switch is set to the correct value as failure to do so will damage the controller.

Two fuses are fitted in the PSU9 power supplies, these are:

Fuse 1 (lower holder) is a 500 mA fuse for the 170 V to 270 V supply.

Fuse 2 (upper holder) is a 1 A for the 85 V to 135 V supply.



## 23.4 PHC9 Mk2 controller connectors

### 23.4.1 Probe interface output

The probe output connector is a 7-pin DIN-type socket that provides for either 5-pin DIN output or 7-pin DIN output signals. The output settings are enabled using the single DIL switch located under the DIN connector. Pin numbers for 5-pin DIN and 7-pin DIN are shown below.

For 5-pin DIN operation:	
Pin number	Description
1	Head LED cathode
2	Screen
3	Head LED anode
4	Probe circuit
5	Probe circuit
For 7-pin DIN operation:	
6	Inhibit (output)
7	Inhibit (output)
For 7-pin DIN output the following switch settings must be set:	
Interface	DIL switch position
PI 4	ON
PI 9	OFF
PI 12	OFF
} See notes below	

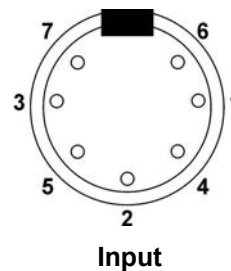

**NOTE:** Renishaw PI 9 interfaces prior to September 1988 required a modification for the probe inhibit function with 7 pin output, however they could work unmodified if the DIL switch was set to ON.

When upgrading obsolete PH9 systems to PH10 systems it is strongly advised to replace any obsolete PI 4, PI 9 and PI 12 interfaces with the current PI 4-2 interface.

### 23.4.2 PHD9 hand controller

An optional PHD9 hand controller may be fitted to the 15-pin D-plug type connector on the rear panel of the PHC9 Mk2.

This enables manual jog and sweep of PH9 or PH9A probe heads to indexed positions and is a useful option when compiling CMM application software part programs. Certain CMM's and software require a PHD9 to be fitted to the PHC9 Mk2 to operate.

**NOTE:** The PHD9 hand controller can only be used with PHC9 Mk2 controllers.

**NOTE:** There are two version types of the PHC9 Mk2 controller, each having a dedicated RS232 or IEEE-488 type connector for communication to and from the CMM PC or controller.

Specific details for each connector type, their signal description and pin numbers are detailed below:

### 23.4.3 RS232 communication connector

The RS232 connector is a 25-pin D-type plug with pin numbers shown below.

Pin number	Description
1	Screen
2	TXD (transmit data)
3	RXD (Receive data)
4	RTS (+12 after completion)
7	Signal ground (common)
20	DTR (+12 V via 470Ω resistor)

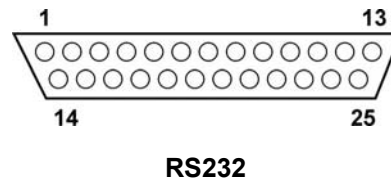

### 23.4.4 IEEE-488 communication connector

The IEEE-488 connector is a 24-pin parallel type plug with pin numbers shown below:

Pin number	Description	Pin number	Description
1	DI01	13	DI05
2	DI02	14	DI06
3	DI03	15	DI07
4	DI04	16	DI08
5	EOI (24)	17	REN (24)
6	DAV	18	GND (6)
7	NRFD	19	GND (7)
8	NDAC	20	GND (8)
9	IFC	21	GND (9)
10	SRQ	22	GND (10)
11	ATN	23	GND (11)
12	SHIELD	24	GND LOGIC

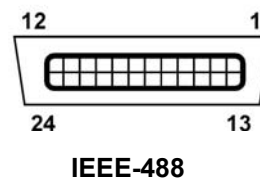

On contact pins 18 to 23 the GND (no.) refers to the signal ground return of the reference contact.

The EOI and REN signals return on contact pin 24.

### 23.4.5 Probe head connector

The probe head connector is a 15-pin D-type socket with the pin numbers shown below:

Pin number	Description
1	Ground sense
2	LED cathode
3	A axis feedback
4	Ground 0 V
5	Head datum
6	DC reference
7	Probe contact 1
8	LED anode
9	Not connected
10	Locking motor
11	A axis motor
12	B axis motor
13	Not connected
14	B axis feedback
15	Probe contact 2

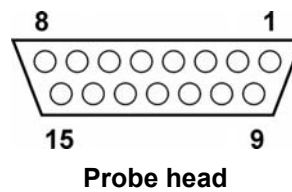

**NOTE:** When checking head and machine cable resistance this value should be under 5  $\Omega$ .

## 24 PHC9 controllers

### 24.1 Description

The PHC9 superseded the older PHC9 Mk2 type controller for PH9 and PH9A motorised probe head systems. There were two communication types for RS232 serial or IEEE-488 parallel communication to and from the CMM PC or controller, each configured by DIL switches.

They are recognisable by a black enclosure and front panel with colour Renishaw product labelling on it. Separate probe interfaces were required for probe signal conditioning.

**The PH9 systems are obsolete and should be replaced or upgraded by PH10 systems.**



**WARNING:** Always disconnect mains power to the PHC9 controller before carrying out service actions or altering switch settings.

### 24.2 PHC9 communication switches

#### 24.2.1 RS232 communication

The RS232 serial communication version PHC9 controller is recognisable by the rear panel connector type and etched 'RS232' text above it. The 12 colour DIL switches on the rear panel are used to set the Baud rate and other functions. Switch settings are detailed below:

	Baud rate							
Switch number	300	600	1200	2400	4800	9600	19200	
1	DOWN	UP	DOWN	UP	DOWN	UP	DOWN	
2	DOWN	DOWN	UP	UP	DOWN	DOWN	UP	
3	DOWN	DOWN	DOWN	DOWN	UP	UP	UP	
4, 5 and 6	Not used for RS232, default to DOWN							
	Function	UP		DOWN				
7	CTS protocol	CTS protocol ON		CTS protocol OFF				
8	LF protocol	LF protocol ON		LF protocol OFF				
9	Not used	Default to DOWN position						
10								
11	Head present	Default to DOWN unless required						
12	SSR polarity	7-pin DIN PHC9 emulation SSR output inhibit during head move			5-pin DIN PHC9 emulation, probe contacts inhibit during head move			



**WARNING:** Always disconnect mains power to the PHC9 controller before carrying out service actions or altering switch settings.

## 24.2.2 IEEE communication

The IEEE parallel communication version PHC9 controller is recognisable by the rear panel connector type and etched 'IEEE' text above it. There are 12 colour DIL switches clearly visible on the rear panel and these are used to set the parallel poll address and other functions.

These switch settings are shown below:

Switch number	Function	
1	1	Least significant bit
2	2	Device address
3	4	(binary coding) range 1 to 30
4	8	
5	16	
6	1	Least significant bit
7	2	Parallel poll
8	4	(binary plus-one coding) range 1 to 8
9	Default to DOWN	
10		
11		
12 SSR polarity	<b>UP</b>	<b>DOWN</b>
	7-pin DIN PHC9 emulation, SSR output inhibit during head move	5-pin DIN PHC9 emulation, probe contacts inhibit during head move

## 24.3 PHC9 controller connectors

### 24.3.1 Probe interface output

The probe output connector is a 7-pin DIN-type socket that provides for either 5-pin DIN output or 7-pin DIN output signals. Pin numbers for 5-pin DIN and 7-pin DIN are shown below:

Pin number	Description	
1	Head LED cathode	
2	Screen	
3	Head LED anode	
4	Probe circuit	
5	Probe circuit	
6	Inhibit (output) see note below	
7	Inhibit (output) see note below	

**NOTE:** These refer to the 7-pin DIN version only and must be used as follows:

DIL switch number	UP	DOWN
11	-	Default to DOWN
12	7-pin	5-pin DIN

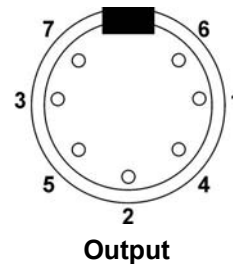

**NOTE:** When upgrading obsolete PH9 systems to PH10 systems it is strongly advised to replace any obsolete PI 4, PI 9 and PI 12 interfaces with the current PI 4-2 interface.

### 24.3.2 PHD10 hand controller

An optional PHD10 hand controller may be fitted to the 15-pin D-plug type connector on the rear panel of the PHC9.

This enables manual jog and sweep of PH9 or PH9A probe heads to indexed positions and is a useful option when compiling CMM application software part programs.

Certain CMM and software types require a PHD10 to be fitted to the PHC9 to operate.

**NOTE:** The PHD10 hand controller must only be used with PHC9 controllers.

### 24.3.3 RS232 communication connector

The RS232 communication connector is a 15-pin D-type plug with pin numbers shown below:

Pin number	Description
1	Screen
2	TXD (transmit data)
3	RXD (Receive data)
4	RTS (+12 after completion)
7	Signal ground (common)
20	DTR (+12 V via 470Ω resistor)

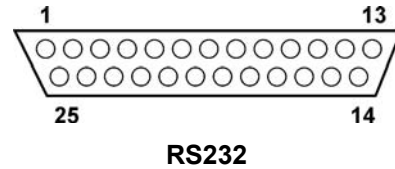

### 24.3.4 IEEE communication connector

The IEEE communication connector is a 15-pin D-type plug with pin numbers shown below:

Pin number	Description	Pin number	Description
1	DI01	13	DI05
2	DI02	14	DI06
3	DI03	15	DI07
4	DI04	16	DI08
5	EOI (24)	17	REN (24)
6	DAV	18	GND (6)
7	NRFD	19	GND (7)
8	NDAC	20	GND (8)
9	IFC	21	GND (9)
10	SRQ	22	GND (10)
11	ATN	23	GND (11)
12	SHIELD	24	GND LOGIC

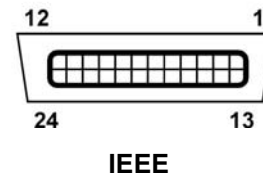

On contact pins 18 to 23 the GND (no.) refers to the signal ground return of the reference contact.

The EOI and REN signals return on contact pin 24.

### 24.3.5 Probe head connector

The probe 3 connector is a 15-pin D-type socket with pin numbers shown below:

Pin number	Description
1	Ground sense
2	LED cathode
3	A axis feedback
4	Ground 0 V
5	Head datum
6	DC reference
7	Probe contact 1
8	LED anode
9	Not connected
10	Locking motor
11	A axis motor
12	B axis motor
13	Not connected
14	B axis feedback
15	Probe contact 2

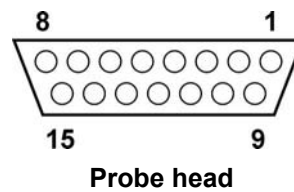

---

**NOTE:** When checking head and machine cable resistance this value should be under 5  $\Omega$ .

---



## 25 PHC10 controllers

### 25.1 Description

The PHC10 was the original controller for PH10T, PH10M and PH10MQ motorised probe head systems. Having both RS232 serial and IEEE-488 parallel communication connectors, it could be configured by the rear panel DIL switches to operate under either communication types.

A separate probe interface was required for probe signal conditioning.

**This PHC10 controller type is now obsolete and should be upgraded to the PHC10-2 type.**



**WARNING:** Always disconnect mains power to the PHC10 controller before carrying out service actions or altering switch settings.

### 25.2 PHC10 communication switches

#### 25.2.1 RS232 communication

The switch settings for RS232 serial communications are detailed below:

	Baud rate						
Switch number	300	600	1200	2400	4800	9600	19200
1	DOWN	UP	DOWN	UP	DOWN	UP	DOWN
2	DOWN	DOWN	UP	UP	DOWN	DOWN	UP
3	DOWN	DOWN	DOWN	DOWN	UP	UP	UP
Switch number	Function	UP			DOWN		
4 and 5	Not used for RS232, default to DOWN						
6	Stop bits	2			1		
7	CTS protocol	CTS protocol ON			CTS protocol OFF		
8	LF protocol	LF protocol ON			LF protocol OFF		
9	PICS during	Probe damping (PDAMP) asserted during head move			Probe inhibit (PPOFF) asserted during head move		
10	Communication protocol	Set up for RS232			IEEE		
11	Probe inhibit	Interface inhibited during move			Probe inhibited during move		
12 and 13	Signal output	PICS output			SSR output		
Mains earth isolation switch		Isolated			Grounded		

## 25.2.2 IEEE communication

The switch settings for IEEE parallel communications are detailed below:

Switch number	Function		
1	1	Least significant bit } Device address (binary coding) range 1 to 30	
2	2		
3	4		
4	8		
5	16		
6	1	Least significant bit } Parallel poll (binary-plus-one coding) range 1 to 8	
7	2		
8	4		
Switch number	Function	UP	DOWN
9	PICS during head move	Probe damping (PDAMP) asserted	Probe inhibit (PPOFF) asserted during head move
10	Communication protocol	RS232	Set DOWN for IEEE
11	Probe inhibit during move	Interface inhibited during move	Probe inhibit during move During head move
12 and 13	Signal output	PICS output	SSR output
Mains earth isolation switch		Isolated	Grounded

## 25.3 PHC10 controller connectors

### 25.3.1 Probe interface output

The probe output connector is a 7-pin DIN-type socket that provides for either 5-pin DIN output or 7-pin DIN output signals. The pin numbers are shown below:

Pin number	Description
1	Head LED cathode
2	Screen
3	Head LED anode
4	Probe circuit
5	Probe circuit
6	Inhibit (output)
7	Inhibit (output)

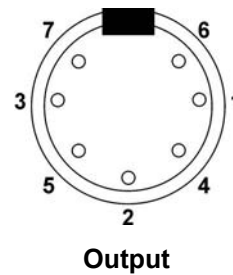

**NOTE:** When upgrading obsolete PH10 controllers to current PHC10-2 types it is strongly advised to replace any obsolete PI 4, PI 9 and PI 12 interfaces with a PI 4-2 interface.

### 25.3.2 PICS input

The PICS input signal connector is a 9-pin D-type socket with the pin numbers shown below:

Pin number	Description
1	STOP
2	Probe power off (PPOFF)
3	0 V
4	Reserved for Renishaw use
5	Probe signal
6	+5 V
7	Probe damping (PDAMP)
8	LED OFF
9	Probe
Body	Screen

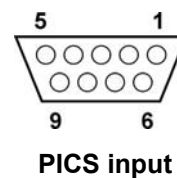

### 25.3.3 PICS output

The PICS output connector is a 9-pin D-type plug with the pin numbers shown below:

Pin number	Description
1	STOP
2	Probe power off (PPOFF)
3	0 V
4	Reserved for Renishaw use
5	SYNC (probe trigger)
6	HALT output
7	Probe damping (PDAMP)
8	LED OFF
9	-
Body	SCREEN

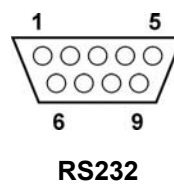

### 25.3.4 PHD10 hand controller

An optional PHD10 hand controller may be fitted to the 15-pin D-plug type connector on the rear panel of the PHC10.

This enables manual jog and sweep of PH10T, PH10M or PH10MQ probe heads to indexed positions and is a useful option when compiling CMM application software part programs.

Certain CMM and software types require a PHD10 to be fitted to the PHC10 to operate.

---

**NOTE:** The PHD10 hand controller must only be used with PHC10 controllers.

---

### 25.3.5 RS232 communication connector

The RS232 communication connector is a 15-pin D-type plug with the pin numbers shown below:

Pin number	Description
1	Screen
2	TXD (transmit data)
3	RXD (Receive data)
4	RTS (+12 after completion)
5	CTS (Clear To Send) from CMM PC, connect pin-4 to pin-5 if CTS is not output from CMM PC.
7	Signal ground (common)
20	DTR

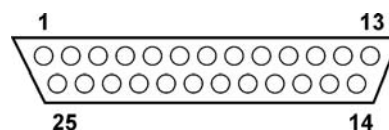

### 25.3.6 IEEE communication connector

The IEEE communication connector is a 15-pin D-type plug with the pin numbers shown below:

Pin number	Description	Pin number	Description
1	DI01	13	DI05
2	DI02	14	DI06
3	DI03	15	DI07
4	DI04	16	DI08
5	EOI (24)	17	REN (24)
6	DAV	18	GND (6)
7	NRFD	19	GND (7)
8	NDAC	20	GND (8)
9	IFC	21	GND (9)
10	SRQ	22	GND (10)
11	ATN	23	GND (11)
12	SHIELD	24	GND LOGIC

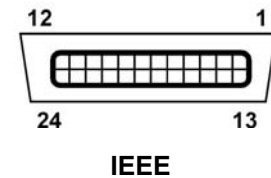

On contact pins 18 to 23 the GND (no.) refers to the signal ground return of the reference contact.

The EOI and REN signals return on contact pin 24.

### 25.3.7 Probe head connector

The probe 3 connector is a 15-pin D-type socket with the pin numbers shown below:

Pin number	Description
1	Ground sense
2	LED cathode
3	A axis feedback
4	Ground 0 V
5	Head datum
6	DC reference
7	Probe contact 1
8	LED anode
9	Not connected
10	Locking motor
11	A axis motor
12	B axis motor
13	Not connected
14	B axis feedback
15	Probe contact 2

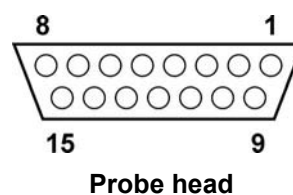

**NOTE:** When checking head and machine cable resistance this value should be under 5  $\Omega$ .

## 26 PHC10-2 controllers

### 26.1 Description

The PHC10-2 is the current controller for PH10T, PH10M and PH10MQ motorised probe head systems. The controllers are available in either RS232 serial or IEEE-488 parallel communication types with configuration DIL switches on the rear panel. A separate probe interface is required for probe signal conditioning.

**The PHC10-2 supersedes PHC10 and replaces the now obsolete PH9 system controllers.**



**WARNING:** Always disconnect mains power to the PHC10-2 controller before carrying out service actions or altering switch settings.

---

## 26.2 PHC10-2 communication switches

### 26.2.1 RS232 communication

The switch settings for RS232 serial communications are detailed below:

Baud rate							
	300	600	1200	2400	4800	9600	19200
<b>Switch 1</b>	DOWN	UP	DOWN	UP	DOWN	UP	DOWN
<b>Switch 2</b>	DOWN	DOWN	UP	UP	DOWN	DOWN	UP
<b>Switch 3</b>	DOWN	DOWN	DOWN	DOWN	UP	UP	UP
Switch	Function		UP		DOWN		
4 and 5	Not used for RS232, default to DOWN						
6	Stop bits		2		1		
7	CTS protocol		CTS protocol ON		CTS protocol OFF		
8	LF protocol		LF protocol ON		LF protocol OFF		
9	Command set		Extended		Basic		
10	Probe reset time		2		1 (default)		
11	PICS configuration		PPOFF – active during head index		PPOFF – inactive during head index		
12	HCU1 probe damp and probe reset button		Enabled		Disabled		
13 and 14	Default to DOWN position						
15 and 16	Interface connection		PICS		DIN (SSR)		
17 and 18	DIN configuration		PICS or 7-pin DIN operation		5-pin DIN operation		
<b>NOTE:</b> Ensure switches 17 and 18 default to UP with switches 15 and 16 for PICS.							

### 26.2.2 IEEE communication

The switch settings for IEEE parallel communications are detailed below:

Switch	Function		
1	1	Least significant } Device address (binary coding) range 1 to 30	
2	2		
3	4		
4	8		
5	16		
6	1	Least significant } Parallel poll (binary-plus-one coding) range 1 to 8	
7	2		
8	4		
Switch	Function	UP	DOWN
9	Default to DOWN position		
10	Probe reset time	2	1 (default)
11	PICS configuration	PPOFF – active during head index	PPOFF – inactive during head index
12	HCU1 probe damp and probe reset buttons	Enabled	Disabled
13 and 14	Default to DOWN position		
15 and 16	Interface connection	PICS	DIN (SSR)
17 and 18	DIN configuration	PICS or 7-pin DIN operation	5-pin DIN operation only
<p><b>NOTE:</b> Ensure switches 17 and 18 default to UP with switches 15 and 16 for PICS.</p>			



## 26.3 PHC10-2 controller connectors

### 26.3.1 Probe interface output

The probe output connector is a 7-pin DIN-type socket that provides for either 5-pin DIN output or 7-pin DIN output signals. Pin numbers for 5-pin DIN and 7-pin DIN are shown below:

Pin number	Description
1	Head LED cathode
2	Screen
3	Head LED anode
4	Probe circuit
5	Probe circuit
6	Inhibit (output)
7	Inhibit (output)

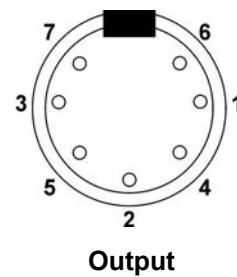

### 26.3.2 PICS input

The PICS input signal connector is a 9-pin D-type socket with pin numbers shown below:

Pin number	Description
1	STOP
2	Probe power off (PPOFF)
3	0 V
4	Reserved for Renishaw use
5	Probe signal
6	+5 V
7	Probe damping (PDAMP)
8	LED OFF
9	Probe
Body	Screen

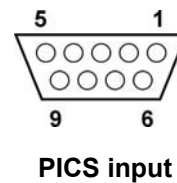

### 26.3.3 PICS output

The PICS output connector is a 9-pin D-type plug with pin numbers shown below:

Pin number	Description
1	STOP
2	Probe power off (PPOFF)
3	0 V
4	Reserved for Renishaw use
5	SYNC (probe trigger)
6	HALT output
7	Probe damping (PDAMP)
8	LED OFF
9	-
Body	SCREEN

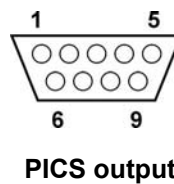

### 26.3.4 HCU1 hand control unit

An optional HCU1 hand control unit may be fitted to the 15-pin D-plug type connector on the rear panel of the PHC10-2.

This enables manual jog and sweep of PH10T, PH10M or PH10MQ probe heads to indexed positions and is a useful option when compiling CMM application software part programs.

Certain CMM and software types require an HCU1 to be fitted to the PHC10-2 to operate.

**NOTE:** The HCU1 hand control unit can only be used with PHC10-2 type controller.

The HCU1 connector is a 9-pin D-type socket with pin numbers shown below:

Pin number	Description
1	-
2	Rx D output
3	Tx d output
4	DTR (data transmit ready) input
5	Signal ground
6	-
7	-
8	CTS (clear to send) output
9	+12 V output
Body	SCREEN

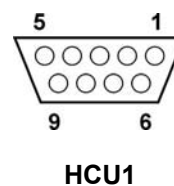

### 26.3.5 RS232 communication connector

The RS232 communication connector is a 15-pin D-type plug with the pin numbers shown below:

Pin number	Description
1	Screen
2	TXD (transmit data)
3	RXD (receive data)
4	RTS (+12 after completion)
5	CTS from CMM, connected pin-5 to pin-20 if CTS is not asserted
7	Signal ground (common)
20	DTR

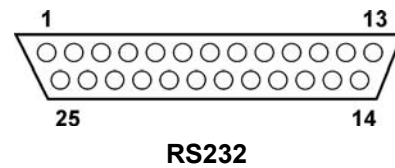

### 26.3.6 IEEE communication connector

The IEEE communication connector is a 15-pin D-type plug with the pin numbers shown below:

Pin number	Description	Pin number	Description
1	DI01	13	DI05
2	DI02	14	DI06
3	DI03	15	DI07
4	DI04	16	DI08
5	EOI (24)	17	REN (24)
6	DAV	18	GND (6)
7	NRFD	19	GND (7)
8	NDAC	20	GND (8)
9	IFC	21	GND (9)
10	SRQ	22	GND (10)
11	ATN	23	GND (11)
12	SHIELD	24	GND LOGIC

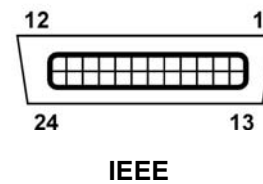

On contact pins 18 to 23 the GND (no.) refers to the signal ground return of the reference contact.

The EOI and REN signals return on contact pin 24.

### 26.3.7 Probe head connector

The probe head connector is a 15-pin D-type socket with the pin numbers shown below:

Pin number	Description
1	Ground sense
2	LED cathode
3	A axis feedback
4	Ground 0 V
5	Head datum
6	DC reference
7	Probe contact 1
8	LED anode
9	Not connected
10	Locking motor
11	A axis motor
12	B axis motor
13	Not connected
14	B axis feedback
15	Probe contact 2

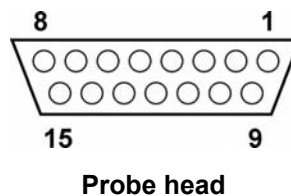

---

**NOTE:** When checking head and machine cable resistance this value should be under 5  $\Omega$ .

---

## 27 PHC50 controllers

### 27.1 Description

The PHC50 was a dedicated controller for the PH50 motorised probe head system. It used RS232 serial communications and was unique in having an internal interface for signal conditioning and output of the dedicated TP50 touch trigger probe.

**The PH50 system is now obsolete and should be replaced or upgraded by a PH10 system.**



**WARNING:** Always disconnect mains power to the PHC50 controller before carrying out service actions or altering switch settings.

---

## 27.2 PHC50 RS232 communication switches

The table below details the configuration switch settings for Version 6 or later PHC50 controllers.

For Version 4 or earlier PHC50 controllers, please contact Renishaw for advice.

All PHC50 controllers must be restarted (powered down and powered up) to allow switch setting changes to take effect. Always make a note of original switch settings before alterations are made.

Baud rate							
	300	600	1200	2400	4800	9600	19200
<b>Switch 1</b>	DOWN	UP	DOWN	UP	DOWN	UP	DOWN
<b>Switch 2</b>	DOWN	DOWN	UP	UP	DOWN	DOWN	UP
<b>Switch 3</b>	DOWN	DOWN	DOWN	DOWN	UP	UP	UP
Switch	Function	UP			DOWN		
4 and 5	Not used for RS232, default to DOWN						
6	Stop bits	2			1		
7	CTS protocol	CTS protocol ON			CTS protocol OFF		
8	LF protocol	LF protocol ON			LF protocol OFF		
9	Command set	Extended			Basic		
10	No function (see note 2) Below.	Default to DOWN position					
11	PPOFF configuration	PPOFF - active during head move. Probe will <b>not</b> trigger if obstructed during a head move			PPOFF - inactive during head move. Probe <b>will</b> trigger if obstructed during a head move		
12	SSR probe polarity	Output polarity inverted SSR open when seated SSR closed when triggered			Output polarity normal SSR closed when seated SSR open when triggered		
13	For Renishaw use only.	Default to DOWN position					
14	STOP disregard	Do not disregard			Disregard		
15	DIN pin-1 output	Head present			LED cathode		
16	Interface selection	Internal interfacing Probe signals passed through the PHC50 and output to an external interface			External interfacing PHC50 interfaces signals internally and output probe status directly to CMM		
17	Buzzer	Enabled			Disabled		
18	SSR polarity	Inverted			Normal		

### NOTE:

- Switches 6, 7 and 8 have no effect when switch 9 is UP (extended command set).
- The 'interface selection' function enabled by switch 10 on previous versions of PHC50 controller (with 14 coloured DIL switches) is now enabled by switch 16 on later units.  
Switch 10 should default to DOWN.

## 27.3 PHC50 controller connectors

### 27.3.1 Probe interface output

The probe output connector is a 7-pin DIN-type socket that provides for either 5-pin DIN output or 7-pin DIN output signals. Pin numbers for 5-pin DIN and 7-pin DIN are shown below:

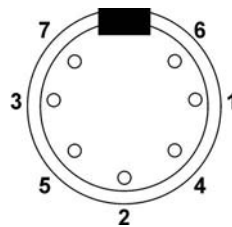

Output

7-pin DIN SSR output connector (socket)			
Switch 15 DOWN		Switch 15 UP	
Pin 1	LED cathode	Pin 1	Head present signal open collector output 500 Ω to 0 V when PH50 is present 24 V max between collector and emitter 0 Ω to 0 V with PH10 cables used 20 mA max current 24 V max between collector and 0 V
Pin 2	0 V	Pin 2	0 V
Pin 3	LED anode	Pin 3	LED anode
Pin 4	Probe return	Pin 4	SSR_B
Pin 5	Probe signal	Pin 5	SSR_A
Pin 6	Inhibit return	Pin 6	-
Pin 7	Inhibit signal	Pin 7	-
Switch 16 DOWN		Switch 16 UP	
External probe interfacing		Internal probe interfacing	
The SSR polarity output is set using switch 18 as shown below.			
Switch 18 UP		Switch 18 DOWN	
SSR open when probe seated		SSR closed when probe seated	
SSR closed when probe triggered		SSR open when probe triggered	

### 27.3.2 PICS input

The PICS input signal connector is a 9-pin D-type socket with the pin numbers shown below:

Pin number	Description
1	STOP
2	Probe power off (PPOFF)
3	0 V
4	Reserved for Renishaw use
5	Probe signal
6	+5 V
7	Probe damping (PDAMP)
8	LED OFF
9	Probe
Body	SCREEN

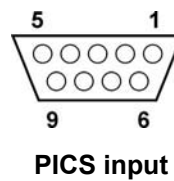

### 27.3.3 PICS output

The PICS output connector is a 9-pin D-type plug with the pin numbers shown below:

Pin number	Description
1	STOP
2	Probe power off (PPOFF)
3	0 V
4	Reserved for Renishaw use
5	SYNC (probe trigger)
6	HALT output
7	Probe damping (PDAMP)
8	LED OFF
9	-
Body	SCREEN

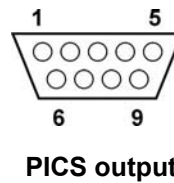



### 27.3.4 HCU1 hand control unit

An optional HCU1 hand control unit may be connected and used with the PHC50 controller.

This enables manual jog and sweep of PH50 probe head to indexed positions and is a useful option when compiling CMM application software part programs.

Certain CMM and software types require fitment of the HCU1 to the PHC50 for them to operate.

**NOTE:** The HCU1 hand control unit can only be used with PHC50 type controller.

### 27.3.5 HCU1 signals

The HCU1 connector is a 9-pin D-type socket with pin numbers shown below:

Pin number	Description
1	-
2	Rx D output
3	Tx D output
4	DTR (data transmit ready) input
5	Signal ground
6	-
7	-
8	CTS (clear to send) output
9	+12 V output
Body	SCREEN

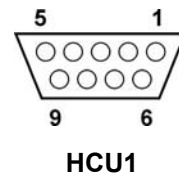

### 27.3.6 RS232 communication connector

The RS232 communication connector is a 15-pin D-type plug with pin numbers shown below:

Pin number	Description
1	Screen
2	TXD (transmit data)
3	RXD (receive data)
4	RTS (+12 after completion)
5	CTS from CMM, connected pin-4 to pin-5 if CTS is not output from CMM
7	Signal ground (common)
20	DTR

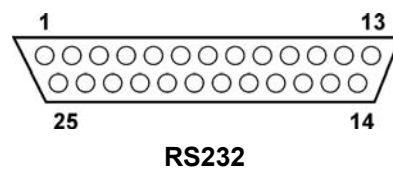

### 27.3.7 Probe head connector

The probe head connector is a 15-pin D-type socket with pin numbers shown below:

Pin number	Description
1	Ground sense
2	0 V
3	A axis feedback 2.8 to 4.1 V
4	Ground 0 V (or head present)
5	Motor / probe switch
6	DC reference 6.0 + 0.05 V
7	B axis motor / probe contact
8	LED anode
9	Probe contact
10	Locking motor 6 V DC nominal
11	A axis motor 6 V DC nominal
12	B axis motor 6 V DC nominal
13	Probe contact
14	B axis DC feedback 0 V / +5 V
15	B axis motor / probe contact
Body	SCREEN

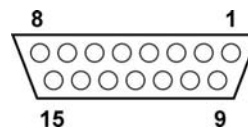

**Probe head**

**NOTE:** When checking head and machine cable resistance this value should be under 5  $\Omega$ .

---

## 28 PHS1 servo positioning head

### 28.1 Description

The PHS1 servo positioning head system currently uses an ISA type control card fitted to either the CMM controller or PC. This card provides axis control but does not condition the system probe signals. A suitable probe interface must be used with this system.

This section provides switch settings, a schematic diagram, signal descriptions and pin numbers for the PHS control card, PHS1 head and cables used with it. As the PHS1 can also be mounted on KM1 or KM2 kinematic mounts, details are provided for signals and pin numbers of these too.



**WARNING:** Always disconnect mains power to the PHS1, cables or control card before carrying out service actions or changing switch settings.

---



**ATTENTION:**

The PHS control card contains static sensitive components.

Observe anti-static handling precautions, including the use of earth straps during handling and installation.

---

**NOTE:** The maximum permissible cable length is 30 m.

It is recommended that the resistance of the power cable should typically be  $3\Omega$  but should not exceed  $5\Omega$  total loop resistance as a thermal fuse and switch mode power supply are configured to monitor the correct voltage to the head. High cable resistance may trigger the thermal fuse.

This is usually evident by the symptom of brief power up, approximately 1 or 2 seconds. Where the head LED lights before extinguishing. Exchanging heads may appear to solve the problem however this is usually due to electrical tolerance differences between systems.

---

## 28.2 PHS1 system schematic diagram

The diagram below shows the connections and pin numbers between the PHS1 servo positioning head, connection cables and the PHS PC ISA card.

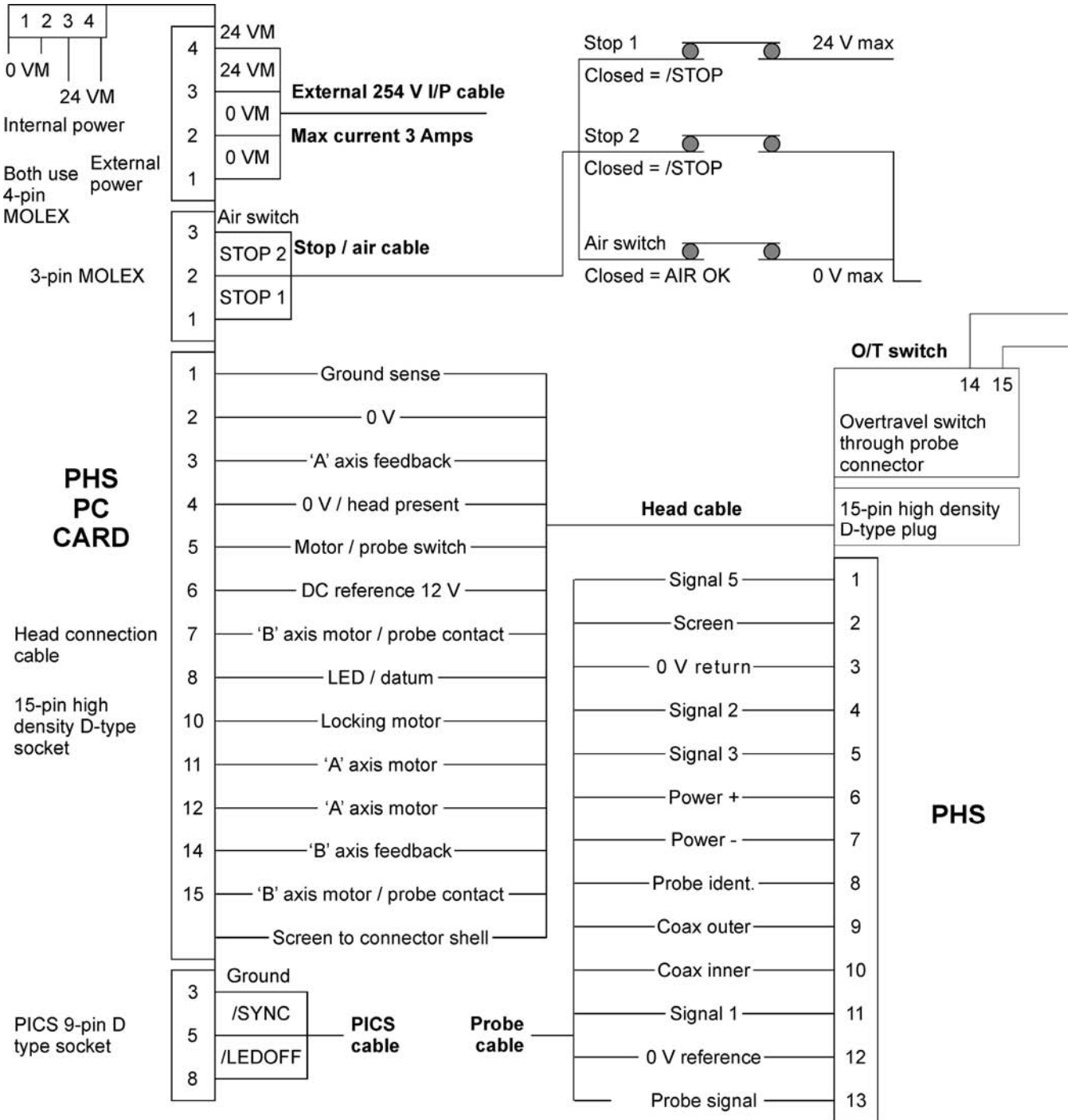

## 28.3 PHS card switches

The PHS card has four sets of DIL switches enabling the correct configuration to be made during fitment. As PHS1 is an established Renishaw product, certain design changes have been made resulting in newer versions of the PHS card being released.



**CAUTION:** Old and new PHS cards differ in both component layout and DIL switch function. Care should be taken when setting switches to prevent system damage.

### 28.3.1 Old and new PHS1 cards

The table below shows old and new type PHS1 cards with a summary of the DIL switch settings:

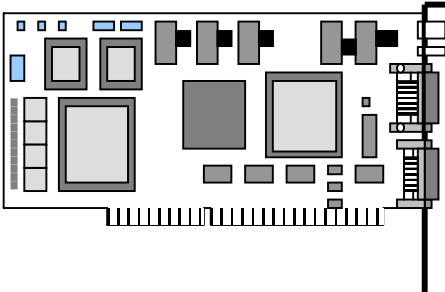
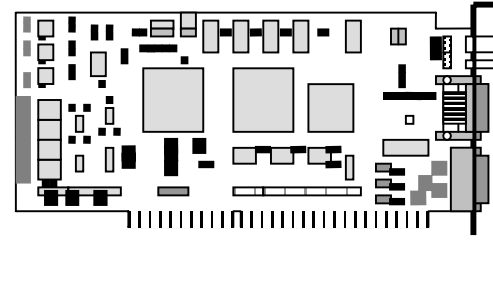
OLD card		NEW card	
Switch	Function	Switch	Function
SW1-1 SW1-2 SW1-3	} Card address selection	SW1-1 SW1-2 SW1-3	} Card address selection
SW2-1 SW2-2 SW2-3		SW2-1 SW2-2 SW2-3	
SW3-1 SW3-2 SW3-3		SW3-1 SW3-2 SW3-3	
SW4-1		SW4-1	
SW4-2		SW4-2	
SW4-3		SW4-3	
<p>Sync edge OFF (left) = rising edge On (right) = falling edge</p>		<p>Not used</p>	
<p>Controller select OFF (left) = IBM-PC bus ON (right) = DELTA-TAU</p>		<p>Sync edge OFF (left) = rising edge On (right) = falling edge</p>	
<p>Not used</p>		<p>Controller select OFF (left) = IBM-PC bus ON (right) = DELTA-TAU</p>	
<p><b>Old type PHS card</b></p> 		<p><b>New type PHS card</b></p> 	

### 28.3.2 PHS1 card primary I/O map mode jumper switches

PHS card address selection is made using input/output map mode jumper switches shown below:

<b>PHS1 I/O MAP mode</b>				
<b>Address</b>	<b>SW1-1</b>	<b>SW1-2</b>	<b>SW1-3</b>	<b>SW2-1</b>
<b>0XXX</b>	LEFT	LEFT	LEFT	LEFT
<b>1XXX</b>	LEFT	LEFT	LEFT	RIGHT
<b>2XXX</b>	LEFT	LEFT	RIGHT	LEFT
<b>3XXX</b>	LEFT	LEFT	RIGHT	RIGHT
<b>4XXX</b>	LEFT	RIGHT	LEFT	LEFT
<b>5XXX</b>	LEFT	RIGHT	LEFT	RIGHT
<b>6XXX</b>	LEFT	RIGHT	RIGHT	LEFT
<b>7XXX</b>	LEFT	RIGHT	RIGHT	RIGHT
<b>8XXX</b>	RIGHT	LEFT	LEFT	LEFT
<b>9XXX</b>	RIGHT	LEFT	LEFT	RIGHT
<b>AXXX</b>	RIGHT	LEFT	RIGHT	LEFT
<b>BXXX</b>	RIGHT	LEFT	RIGHT	RIGHT
<b>CXXX</b>	RIGHT	RIGHT	LEFT	LEFT
<b>DXXX</b>	RIGHT	RIGHT	LEFT	RIGHT
<b>EXXX</b>	RIGHT	RIGHT	RIGHT	LEFT
<b>FXXX</b>	RIGHT	RIGHT	RIGHT	RIGHT

### 28.3.3 PHS1 card secondary I/O map mode jumper switches

Further PHS card address selection is made using more input/output map mode jumper switches, as shown below:

PHS1 I/O MAP mode				
Address	SW1-1	SW1-2	SW1-3	SW2-1
0XXX	LEFT	LEFT	LEFT	LEFT
1XXX	LEFT	LEFT	LEFT	RIGHT
2XXX	LEFT	LEFT	RIGHT	LEFT
3XXX	LEFT	LEFT	RIGHT	RIGHT
4XXX	LEFT	RIGHT	LEFT	LEFT
5XXX	LEFT	RIGHT	LEFT	RIGHT
6XXX	LEFT	RIGHT	RIGHT	LEFT
7XXX	LEFT	RIGHT	RIGHT	RIGHT
8XXX	RIGHT	LEFT	LEFT	LEFT
9XXX	RIGHT	LEFT	LEFT	RIGHT
AXXX	RIGHT	LEFT	RIGHT	LEFT
BXXX	RIGHT	LEFT	RIGHT	RIGHT
CXXX	RIGHT	RIGHT	LEFT	LEFT
DXXX	RIGHT	RIGHT	LEFT	RIGHT
EXXX	RIGHT	RIGHT	RIGHT	LEFT
FXXX	RIGHT	RIGHT	RIGHT	RIGHT

## 28.4 PHS card connectors

### 28.4.1 Probe head connector

This connector is a 15-pin high density D-type socket. Signal descriptions and pin numbers are shown below:

Pin number	Description
1	Ground sense
2	0 V
3	'A' axis feedback
4	0 V / head present
5	Motor / probe switch
6	DC reference 12 V
7	'B' axis motor / probe contact
8	LED / datum
9	Locking motor
10	'A' axis motor
11	'A' axis motor
12	'B' axis feedback
14	'B' axis motor / probe contact
15	SHELL

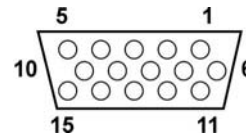

### 28.4.2 PICS connector

The PICS (product inter-connection system) connector is a 9-pin D-type socket. Signal descriptions and pin numbers are shown below:

Pin number	Description
1	Not connected
2	Not connected
3	GND
4	Not connected
5	SYNC signal, see note below
6	Not connected
7	Not connected
8	LED OFF
9	Not connected
Body	SCREEN

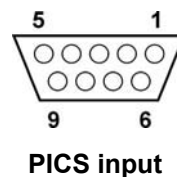

**NOTE:** This SYNC signal can be used as a probe trigger input to the PC interface card to latch the PHS1 head position. Refer to the PHS1 programmer's guide for further details.



### 28.4.3 External 24 V DC power input connector



**WARNING:** Maximum total current through the connector must be 3 Amps. Input power must be provided by a 24 V DC SELV (safety extra low voltage) unit complying with the essential requirements of EN ISO 61010 or a similar specification.

The 4-pin Molex-type connector can be used to input 24 V DC power to the PHS1 via an external cable. Signal descriptions and pin-numbers are shown below:

Pin number	Description
Pin 1	0 V
Pin 2	0 V
Pin 3	24 V DC
Pin 4	24 V DC

**NOTE:** This internal power supply connector can be used to supply PHS1 motor power instead of the external 24 V DC connector. Applying 24 V DC through this connector will automatically select the internal connector and disable the external connector.

### 28.4.4 Air / stop signal input connector

The 3-pin Molex-type connector is used for input of the air / stop signals. Pin numbers and signal descriptions are shown below:

Pin number	Description
Pin 1	STOP 1, connected to 25 V
Pin 2	STOP 2, connected to 0 V
Pin 3	Air switch

**NOTE:** The 3-pin Molex-type connector is rated at 30 Volts DC and 1 Amp maximum. At least one of the STOP lines must be through an EMERGENCY STOP button (open = STOP). Connect air switch to 0 V through a pressure switch (switch closed = pressure OK).

### 28.4.5 Internal 24 V DC power input connector

---



**WARNING:** Maximum total current through the connector must be 3 Amps. Input power must be provided by a 24 V DC SELV (safety extra low voltage) unit complying with the essential requirements of EN ISO 61010 or a similar specification.

---

The 4-pin Molex-type connector can be used to input 24 V DC power to the PHS1 via an internal cable. Signal descriptions and pin-numbers are shown below:

Pin number	Description
Pin 1	0 V
Pin 2	0 V
Pin 3	24 V DC
Pin 4	24 V DC

---

**NOTE:** This internal power supply connector can be used to supply PHS1 motor power instead of the external 24 V DC connector.

Applying 24 V DC through this connector will automatically select the internal connector and disable the external connector.

---

## 29 KM1 and KM2 kinematic mounts

### 29.1 Description

The KM1 and KM2 kinematic mounts enable repeatable changing between probe head systems and probes. The KM1 provides for through the quill electrical connection of devices and the KM2 enables round the quill connection using external cables.

The table below details which adapter combination is used for each head or probe unit:

Adapter	Head or probe system
KM1 (through quill cabling)	PHS1 to PH10MQ
KM2 (round quill cabling)	PHS1 to PH10T or PH10M
KM1 or KM2 and PHA3	PH10MQ
KM1 or KM2 and PHA80	SP80

Adapters can be locked on or removed using a Renishaw S10 autojoint key.

### 29.2 KM1 kinematic mount connectors.

The KM1 through the quill mounting plate shown below identifies the connectors with the signal descriptions and pin numbers shown in the following tables.

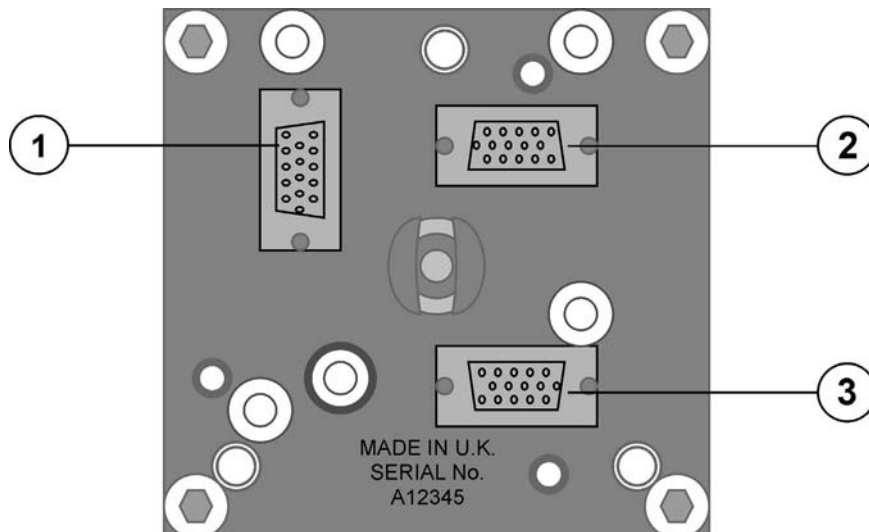

### 29.3 Motorised head connector

The motorised head connector (item '1' shown on page 120) on the KM1 and KM2 is a high density 15-pin D-type socket. Pin numbers and signal descriptions are shown below:

KM1 and KM2 pin number	Description	PHS1 pin number
Pin 1	Ground sense	Pin 1
Pin 2	0 V	Pin 2
Pin 3	'A' axis feedback	Pin 3
Pin 4	0 V / head present	Pin 4
Pin 5	Motor / probe switch	Pin 5
Pin 6	DC reference 12 V	Pin 6
Pin 7	'B' axis motor / probe contact	Pin 7
Pin 8	LED / datum	Pin 8
Pin 10	Locking motor	Pin 10
Pin 11	'A' axis motor	Pin 11
Pin 12	'A' axis motor	Pin 12
Pin 14	'B' axis feedback	Pin 14
Pin 15	'B' axis motor / probe contact	Pin 15
SCREEN	SHELL	SCREEN

### 29.4 PHS communication and power cable

The communication and power cable connector (item '2' shown on page 120) on the KM1 and KM2 are high density 15-pin D-type sockets. Pin numbers and signal descriptions are shown below:

KM1 and KM2 pin number	Communication cable	PHS pin number
Pin 3	(BLACK) Twisted pair data FROM head	Pin 3
Pin 5	(RED) Twisted pair data FROM head	Pin 5
Pin 8	(BLACK) Twisted pair data TO head	Pin 8
Pin 10	(WHITE) Twisted pair data TO head	Pin 10
SHELL	SCREEN	SHELL
KM1 and KM2 pin number	Power cable	PHS pin number
Pin 6	(BLUE) +24 V	Pin 6
Pin 7	(YELLOW) 0 V M	Pin 7
Pin 11	(GREY) +24 V	Pin 11
Pin 12	(PINK) 0 V M	Pin 12
Pin 14	(WHITE) 0 12 V	Pin 14
Pin 15	(BROWN) Ground	Pin 15
SHELL	SCREEN	SHELL

## 29.5 PHS probe cable

The probe and overtravel cable connector (item '3' shown on page 120) of the KM1 and KM2 is a high density 15-pin D-type socket. Pin numbers and signal description are shown below:

<b>KM1 and KM2 pin number</b>	<b>Probe cable</b>	<b>PHS pin number</b>
Pin 1	(BROWN) Signal 5	Pin 1
Pin 2	(BLACK / WHITE) Screen	Pin 2
Pin 3	(GREEN) 0 V return	Pin 3
Pin 4	(VIOLET) Signal 2	Pin 4
Pin 5	(YELLOW) Signal 3	Pin 5
Pin 6	(RED) Power +	Pin 6
Pin 7	(BLUE) Power –	Pin 7
Pin 8	(WHITE) Probe identification	Pin 8
Pin 9	COAXIAL OUTER	Pin 9
Pin 10	COAXIAL INNER	Pin 10
Pin 11	(ORANGE) Signal 1	Pin 11
Pin 12	(BLUE / WHITE) 0 V reference	Pin 12
Pin 13	(GREY) Probe signal	Pin 13
Fit parallel with pin 3 for OTP6M / OTP3M	BROWN / WHITE cut back if not required	Fit parallel with pin 3 for OTP6M / OTP3M
SHELL	SCREEN	SHELL
<b>KM1 and KM2 pin number</b>	<b>Overtravel cable</b>	<b>PHS pin number</b>
Pin 14	WHITE	N/A
Pin 15	BROWN	N/A
Crimp male contact		

## 30 Autochange controllers

### 30.1 Description

Autochange controllers drive the ACR1 rack system under commands from the CMM PC using RS232 serial mode or IEEE parallel mode communications.

Alternatively, 'stand-alone mode' can be enabled to allow the controller to operate in isolation using time-based commands derived from the order in which the rack port lids are operated. Regardless of the age of units, communication type or whether stand-alone mode is being used, a common command set language is used to 'talk' between the autochange controller and the rack.

- ACC1 is now obsolete and was the original version, support is only available by upgrade to ACC2-2.
- ACC2 is also obsolete and was the main production version with support available by upgrade only to the ACC2-2.
- ACC2-2 is the current version controller.
- Integration of autochange systems should be done by a competent CMM service provider or the machine manufacturer.

Original flat foil screened rack cables connecting the ACC2 to the ACR1 rack are also obsolete and they have been superseded by round cables with a braided screen.

---

**NOTE:** Although existing system equipment is cross compatible with current units, it is advised to upgrade where possible for preventive maintenance and to ensure compliance to statutory requirements on electromagnetic interference protection.

---

## 30.2 ACC1 controller switches

### 30.2.1 ACC1 RDI (rack drive interface) board

The ACC1 rack drive interface board consists of two sets of DIL switches SW1 has two elements and SW2 has four elements to enable the signal output for the system and the switch settings are shown below.

SW1		SW2				OUTPUT
1 Brown	2 Red	1 Brown	2 Red	3 Orange	4 Yellow	
0	1	0	0	See notes below		OCT
1	1	0	0			TTL
0	0	0	1			SSR normally OPEN
0	0	1	0			SSR normally CLOSED

#### NOTES: Rack drive interface (RDI) board

The output selection and buzzer option switches are mounted on the RDI board. To select the required output:

1. Switch the ACC1 off before changing codes, otherwise damage may occur.
2. Select your output by setting the elements of switches SW1 and SW2 (elements 1 and 2 on each switch) as shown in the table.

Switch SW2, element 3 (orange) is 'don't care'.

3. Select buzzer ON or OFF by switching element 4 (yellow) on switch SW2:

Buzzer ON = 1

Buzzer OFF = 0

### 30.2.2 ACC1 RS232 serial communication switches

To enable RS232 serial communications, set switch 4 (yellow) on IC12 to 0, then set switches 1, 2 and 3 to the required Baud rate shown below:

Baud rate	Switch		
	Brown 1	Red 2	Orange 3
300	1	1	0
600	1	0	1
1200	1	0	0
2400	0	1	1
4800	0	1	0
9600	0	0	1
19200	0	0	0
INVALID	1	1	1

### 30.2.3 ACC1 IEEE-488 parallel communication switches

To enable IEEE-488 parallel communications the device address and parallel poll bit must be set on the microcomputer board. Then set switch 4 (Yellow) on IC12 to 1 and set the 8 switches on IC31 to the required device address (0 to 31) and parallel poll bit (1 to 8) as shown below.

PARALLEL POLL BIT	Grey 8	Purple 7	Blue 6	DEVICE ADDRESS	Green 5	Yellow 4	Orange 3	Red 2	Brown 1
1	0	0	0	0	0	0	0	0	0
2	0	0	1	1	0	0	0	0	1
3	0	1	0	2	0	0	0	1	0
4	0	1	1	3	0	0	0	1	1
5	1	0	0	4	0	0	1	0	0
6	1	0	1	-	-	-	-	-	-
7	1	1	0	-	-	-	-	-	-
8	1	1	1	31	1	1	1	1	0
				32	1	1	1	1	1



### 30.2.4 ACC1 stand-alone mode switches

Stand-alone mode operation allows the ACR1 rack to be operated without any communications link between the ACC1 and the CMM controller or PC. It relies upon the order in which the rack infrared light beams are broken as ports open or close as a probe is parked or picked-up. Different time-delays can be set for the ACR1 rack operation using the DIL switches.

### 30.2.5 Stand-alone mode selection

Stand-alone mode is selected using the four element switches on IC 12 of the microprocessor board. The switch selections are as follows:

Switch	Position
1	ON (UP)
2	ON (UP)
3	ON (UP)
4	OFF (DOWN)

### 30.2.6 Stand-alone time delay

The delay-time is selected using the eight element switches on IC 31 on the microprocessor board. The five switches are used to set the delay-time in 0.2 second steps and are binary coded.

Switch	Position	Delay time
1	ON (UP)	0.2 seconds
2	ON (UP)	0.4 seconds
3	ON (UP)	0.8 seconds
4	ON (UP)	1.6 seconds
5	ON (UP)	3.2 seconds

Example: Switch 1 (0.2 sec) and switch 3 (0.8 sec) set to ON (UP) would equal 1.0 seconds.

## 30.3 ACC1 controller connectors

### 30.3.1 SK1 probe head connector

The SK1 probe head connector is a 15-pin D-type socket, the signal descriptions and pin numbers are detailed below:

Pin number	Description
1	-
2	I/F LED K, probe LED cathode
3	-
4	-
5	-
6	-
7	T probe contact 1
8	I/F LED A, probe LED anode
9	0 V, cable screen
10	-
11	-
12	-
13	-
14	-
15	T probe contact

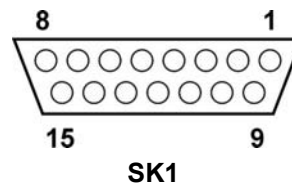

### 30.3.2 PL1 - RS232 serial communication connector

The PL1 RS232 serial communication connector is a 25-pin D-type plug.

Signal descriptions and pin numbers are shown below:

Pin number	Description
11	0 V screen (ACC1 chassis)
2	TXD transmit data, output from ACC1
3	RXD receive data, input to ACC1
4	RTS ready to send, output from ACC1
5	CTS clear to send, input to ACC1
7	0 V signal common to ACC1 chassis

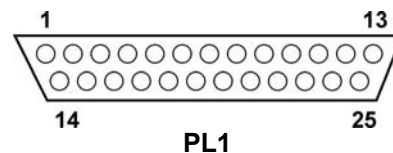

- NOTE:**
- RTS is active (high) when a message is waiting to be transmitted. It is cleared after the last byte of the message has been transmitted.
  - CTS is monitored by the ACC1 and transmission is halted if CTS goes inactive (low), it is resumed when it goes active (high). CTS MUST be linked to RTS if not used by the CMM.

### 30.3.3 SK2 rack RS232 communication cable connector

The SK2 rack RS232 communication connector is a 25-pin D-type socket.

Signal descriptions for this communication selection with pin numbers are shown below:

Pin number	Description
1	Rack MOT, supply to ACR1 Motor
2	Rack MOTRET, 0Volt motor return
3	Rack 0 V
4	POT F/B, 'screwdriver' position feedback
5	R. DETECT, rear IRED beam signal
6	Rack probe contact 2
7	Rack REF, precision reference voltage for ACR1 position potentiometer
8	IND 4, rack lock error indicator
9	Rack 0 V
10	IND 0, rack 'change cycle' indicator
11	Rack 0 V
12	Rack 0 V
13	-
14	Rack MOT, supply to ACR1 motor
15	Rack MOTRET, 0 V motor return
16	Rack 0 V
17	F. DETECT, front IRED beam signal
18	Rack probe contact 1
19	O/T 1, overtravel signal
20	IND 1, 'probe active' indicator
21	IND 3, 'cycle error' indicator
22	+18 V supply to circuits
23	Ground sense
24	Rack 0 V
25	Rack 0 V

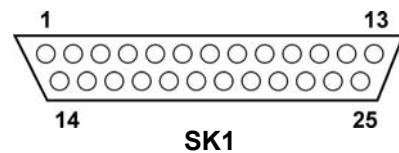

### 30.3.4 TB1 24 V DC supply

The three TB1 connectors are where the 24 V DC power inlet is for the ACC1 from a step-down transformer. The three screw-on connectors are for +24 V, 0 V, and -24 V as shown below:

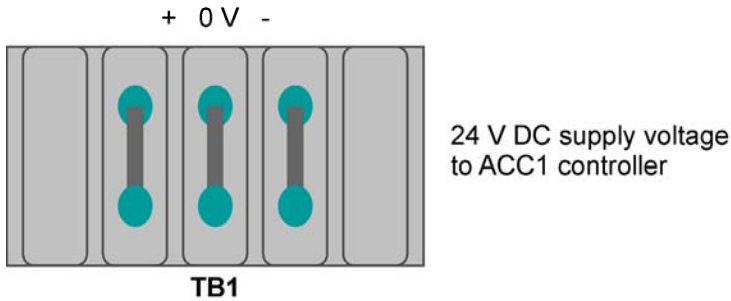

### 30.3.5 SK3 TTL output

The SK3 connector is a 5-pin DIN-type socket providing TTL (transistor transistor logic) output.

Signal descriptions and pin numbers are detailed below:

TTL (transistor transistor logic) digital	
TTL	Pin 3
0 V screen	Pin 1
	Pin 2

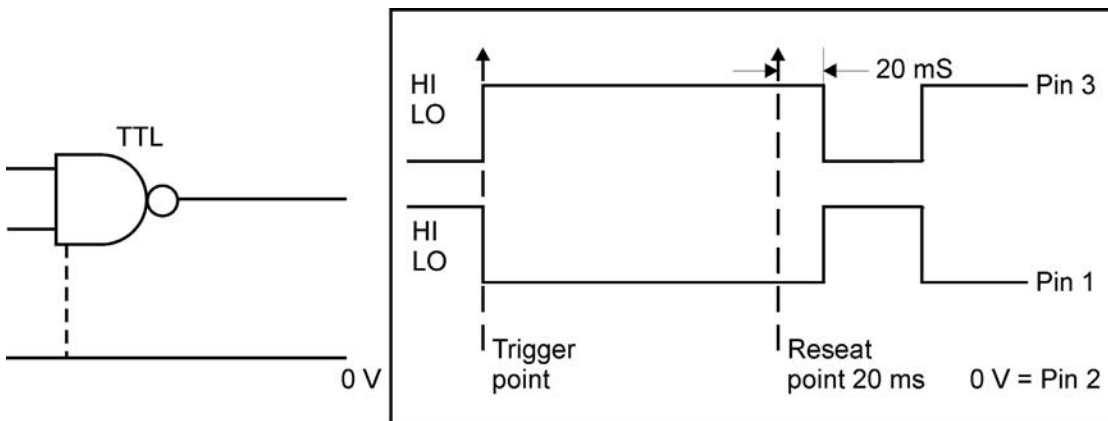
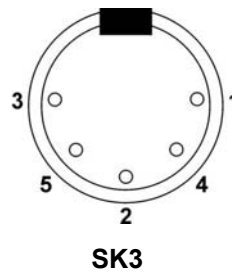

### 30.3.6 SK3 SSR output

The SK3 connector is a 5-pin DIN-type socket providing SSR (solid state relay) output.

Signal descriptions (shown normally open here) and pin numbers are detailed below:

SSR (solid state relay) dry switching	
SSR	Pin 3
	Pin 1
0 V screen	Pin 2

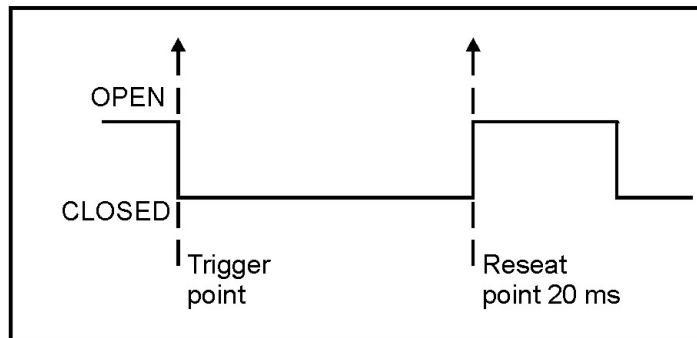
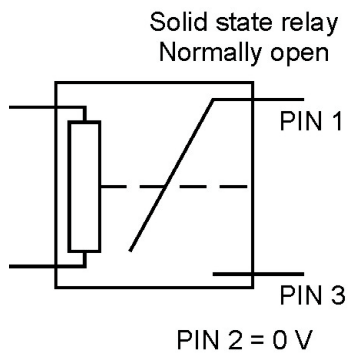
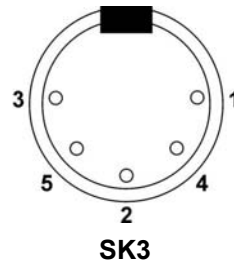

### 30.3.7 SK3 SSR output

The SK3 connector is a 5-pin DIN-type socket providing SSR (solid state relay) output.

Signal descriptions (shown normally closed here) and pin numbers are detailed below:

SSR (solid state relay) dry switching	
SSR	Pin 3
	Pin 1
0 V screen	Pin 2

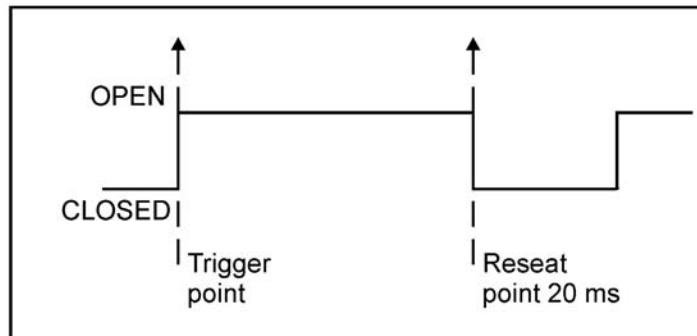
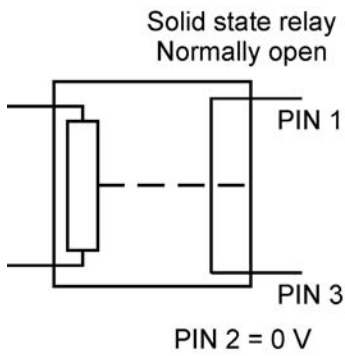
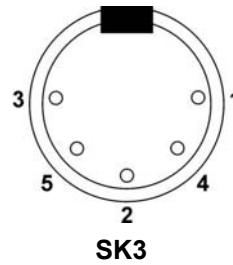

### 30.3.8 SK3 OCT output

The SK3 connector is a 5-pin DIN-type socket providing OCT (open collector transistor) output.

Signal descriptions and pin numbers are detailed below:

OCT (open collector transistor) analogue	
OCT	Pin 3
0 V screen	Pin 1
	Pin 2

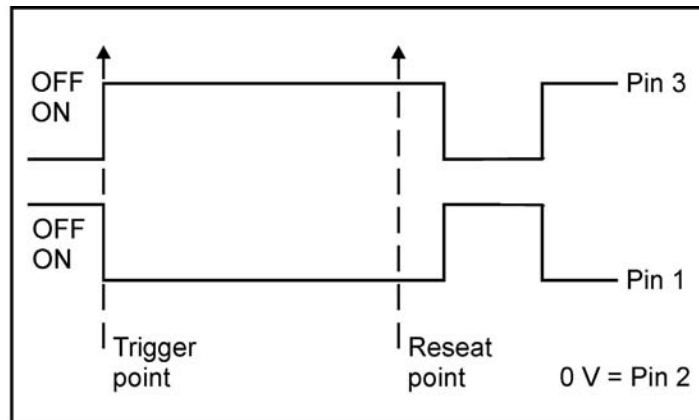
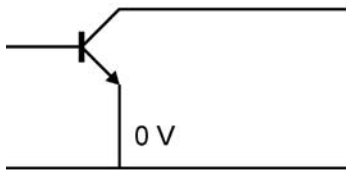
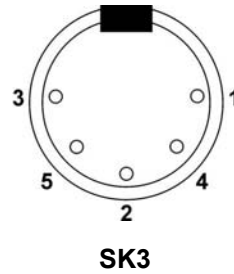

### 30.3.9 SK2 rack IEEE communication cable connector

The SK2 rack IEEE communication connector is a parallel 24-pin D-type socket.

Signal descriptions for this communication selection with pin numbers are shown below:

Pin number	Description	Pin number	Description
1	DI01	13	DI05
2	DI02	14	DI06
3	DI03	15	DI07
4	DI04	16	DI08
5	EOI (24)	17	REN (24)
6	DAV	18	GND (6)
7	NRFD	19	GND (7)
8	NDAC	20	GND (8)
9	IFC	21	GND (9)
10	SRQ	22	GND (10)
11	ATN	23	GND (11)
12	SHIELD	24	GND LOGIC

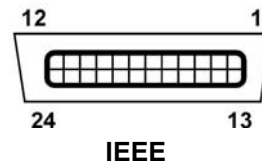

---

**NOTE:** GND(n) refers to the signal ground return of the reference contact. EOI and REN return on contact 24.

---



## 30.4 ACC2 controller switches

### 30.4.1 ACC2 RS232 communication switches

The switch settings for RS232 serial communication operation are shown below:

Switch	Baud rate							
	300	600	1200	2400	4800	9600	19200	57600
1	DOWN	UP	DOWN	UP	DOWN	UP	DOWN	UP
2	DOWN	DOWN	UP	UP	DOWN	DOWN	UP	UP
3	DOWN	DOWN	DOWN	DOWN	UP	UP	UP	UP
Switch	Function		UP			DOWN		
4 and 5	Not used for RS232, default to DOWN							
6	Stop bits		2			1		
7	CTS protocol		CTS protocol ON			CTS protocol OFF		
8	LF protocol		LF protocol ON			LF protocol OFF		
9	Signal outputs		PICS output			SSR output		
10	Handshake		Hardware handshake			DTR signal HI		
11	Probe inhibit		Interface inhibited during move			Probe inhibited during move		
12	Communication protocol		Set to UP for RS232 comms					
Function		Switch 13		Switch 14		Switch 15		
SSR closed on SK3 pins 3 and 1		Can be either		DOWN		DOWN		
SSR open on SK3 pins 3 and 1		Can be either		DOWN		UP		
OCT normally LO on pin 3		DOWN		UP		Can be either		
OCT normally HI on pin 1		DOWN		UP		Can be either		
TTL normally LO on pin 3		UP		UP		Can be either		
TTL normally HI on pin 1		UP		UP		Can be either		
Earth condition switch		Isolated, UP				Grounded, DOWN		

### 30.4.2 ACC2 IEEE communication switches

The switch settings for IEEE parallel communication operation are shown below:

Switch					Function	
<b>1</b>	<b>2</b>	<b>3</b>	<b>4</b>	<b>5</b>	<b>Address (binary code)</b>	
D	D	D	D	D	0	
U	D	D	D	D	1	
D	U	D	U	U	2	
-	-	-	-	-	-	
-	-	-	-	-	-	
D	U	U	U	U	30	
U	U	U	U	U	31	
<b>6</b>	<b>7</b>	<b>8</b>			<b>Parallel poll (binary-plus-one code)</b>	
D	D	D			1	
U	D	D			2	
D	U	D			3	
U	U	D			4	
D	D	U			5	
U	D	U			6	
D	U	U			7	
U	U	U			8	
9	Signal outputs			PICS output		SSR output
10	Handshake			Hardware handshake		DTR signal HI
11	Probe inhibit			Interface inhibited during move		Prone inhibited during move
12	Communication protocol			Set to DOWN for IEEE comms		
<b>Function</b>				<b>Switch 13</b>	<b>Switch 14</b>	<b>Switch 15</b>
SSR closed on SK3 pins 3 and 1				Can be either	DOWN	DOWN
SSR open on SK3 pins 3 and 1				Can be either	DOWN	UP
OCT normally LO on pin 3				DOWN	UP	Can be either
OCT normally HI on pin 1				DOWN	UP	Can be either
TTL normally LO on pin 3				UP	UP	Can be either
TTL normally HI on pin 1				UP	UP	Can be either
Earth condition switch				Isolated, UP		Grounded, DOWN

### 30.4.3 ACC2 stand-alone mode switches

Stand-alone mode operation allows the ACR1 rack to be operated without any communications link between the ACC2 and the CMM controller or PC. It relies upon the order in which the rack infrared light beams are broken as ports open or close as a probe is parked or picked-up. Different time-delays can be set for the ACR1 rack operation using the DIL switches.

The switch settings for stand-alone mode operation are shown below:

Switch	Function	UP	DOWN
1	Delay timing	0.2 s	0.0 s
2	Delay timing	0.4 s	0.0 s
3	Delay timing	0.8 s	0.0 s
4	Delay timing	1.6 s	0.0 s
5	Delay timing	3.2 s	0.0 s
6, 7 and 8	Not used in stand-alone mode		
9	Signal outputs	PICS output	SSR output
10	Handshake	Hardware handshake	DTR signal HI
11 and 12	Set to stand-alone mode		
Function	Switch 13	Switch 14	Switch 15
SSR closed on SK3 pins 3 and 1	Can be either	DOWN	DOWN
SSR open on SK3 pins 3 and 1	Can be either	DOWN	UP
OCT normally LO on pin 3	DOWN	UP	Can be either
OCT normally HI on pin 1	DOWN	UP	Can be either
TTL normally LO on pin 3	UP	UP	Can be either
TTL normally HI on pin 1	UP	UP	Can be either
Earth condition switch	Isolated, UP		Grounded, DOWN

## 30.5 ACC2-2 controller switches

### 30.5.1 ACC2-2 RS232 communication switches

The switch settings for RS232 serial communication operation are shown below:

Switch	Baud rate							
	300	600	1200	2400	4800	9600	19200	56700
1	DOWN	UP	DOWN	UP	DOWN	UP	DOWN	UP
2	DOWN	DOWN	UP	UP	DOWN	DOWN	UP	UP
3	DOWN	DOWN	DOWN	DOWN	UP	UP	UP	UP
Switch	Function		UP			DOWN		
4 and 5	Not used for RS232, default to DOWN							
6	Stop bits		2			1		
7	CTS protocol		CTS protocol ON			CTS protocol OFF		
8	LF protocol		LF protocol ON			LF protocol OFF		
9	Signal outputs		PICS output			SSR output		
10	Handshake		Hardware handshake			DTR signal HI		
11	Probe inhibit		Set to DOWN position for RS232 comms					
12	Communication protocol		Set to UP for RS232 comms					
A and B	Reserved for Renishaw use		Default to DOWN position					

### 30.5.2 ACC2-2 IEEE communication switches

The switch settings for IEEE parallel communication operation are shown below:

Switch					Function	
<b>1</b>	<b>2</b>	<b>3</b>	<b>4</b>	<b>5</b>	<b>Address (binary code)</b>	
D	D	D	D	D	0	
U	D	D	D	D	1	
D	U	D	U	U	2	
-	-	-	-	-	-	
-	-	-	-	-	-	
D	U	U	U	U	30	
U	U	U	U	U	31	
<b>6</b>	<b>7</b>	<b>8</b>			<b>Parallel poll (binary-plus-one code)</b>	
D	D	D			1	
U	D	D			2	
D	U	D			3	
U	U	D			4	
D	D	U			5	
U	D	U			6	
D	U	U			7	
U	U	U			8	
9	Signal outputs				PICS output	SSR output
10	Handshake				Hardware handshake	DTR signal HI
11	Probe inhibit				Interface inhibited during move	Prone inhibited during move
12	Communication protocol				Set to DOWN for IEEE comms	
A and B	Reserved for Renishaw use				Set to Down	

### 30.5.3 ACC2-2 stand-alone mode switches

Stand-alone mode operation allows the ACR1 rack to be operated without any communications link between the ACC2-2 and the CMM controller or PC. It relies upon the order in which the rack infrared light beams are broken as ports open or close as a probe is parked or picked-up. Different time-delays can be set for the ACR1 rack operation using the DIL switches.

The switch settings for stand-alone mode operation are shown below:

Switch	Function	
	UP	DOWN
1	0.2 s	0.0 s
2	0.4 s	0.0 s
3	0.8 s	0.0 s
4	1.6 s	0.0 s
5	3.2 s	0.0 s
6, 7 and 8	Not used in stand-alone mode	
9	<b>Signal outputs</b>	PICS output      SSR output
10	<b>Handshake</b>	Hardware handshake      DTR signal HI
11 and 12	Set to UP for stand-alone mode	
A and B	Default to DOWN	

## 30.6 ACC2 and ACC2-2 controller connectors

### 30.6.1 PICS input

The ACC2 and ACC2-2 PICS input connectors are 9-pin D-type sockets, signal descriptions and pin numbers are detailed below:

Pin number	Description
1	STOP
2	Probe power off (PPOFF)
3	0 V
4	Reserved for Renishaw use
5	Probe signal
6	Spare
7	Probe damping (PDAMP)
8	LED OFF
9	Probe
Body	SCREEN

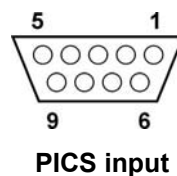

### 30.6.2 PICS output

The ACC2 and ACC2-2 output connectors are 9-pin D-type plugs, signal descriptions and pin numbers are detailed below:

Pin number	Description
1	STOP
2	Probe power off (PPOFF)
3	0 V
4	Reserved for Renishaw use
5	SYNC output (probe trigger)
6	Spare
7	Probe damping (PDAMP)
8	LED OFF
9	Probe
Body	SCREEN

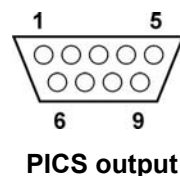

### 30.6.3 Rack communication

The rack communication connectors on the ACC2 and ACC2-2 controllers are 25-pin D-type sockets. Signal descriptions and pin numbers are shown below:

Pin number	Description
1	Rack MOT, supply to ACR1 Motor
2	Rack MOTRET, 0 V motor return
3	Rack 0 V return for ACR1 motor
4	POT F/B, 'screwdriver' position feedback
5	R. DETECT, rear IRED beam signal
6	Rack probe contact 2
7	Rack REF, precision reference voltage for ACR1 position potentiometer
8	IND 4, rack lock error indicator
9	Rack 0 V, ACR1 0 V
10	IND 0, rack 'change cycle' indicator
11	Rack 0 V, reserved for future use
12	Rack 0 V, reserved for future use
13	-
14	Rack MOT, supply to ACR1 motor
15	Rack MOTRET, 0 V motor return
16	Rack 0 V
17	F. DETECT, front IRED beam signal
18	Rack probe contact 1
19	O/T 1, ACR1 overtravel signal
20	IND 1, ACR1 'probe active' indicator
21	IND 3, ACR1 'cycle error' indicator
22	+15 V supply to ACR1 circuits
23	Ground sense
24	Rack 0 V, reserved for future use
25	Rack 0 V, reserved for future use

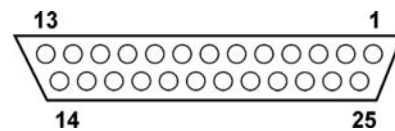



### 30.6.4 SSR output

The SSR output connectors on the ACC2 and ACC2-2 controllers are 5-pin DIN-type sockets. Signal descriptions and pin numbers are shown below:

Pin number	Description
1	Probe output *, high or open circuit for a seated probe
2	0 V (digital) ground reference <b>NOT to be connected to cable screen</b>
3	Probe output *, low or short circuit for a seated probe
4	Not used
5	External reset
Chassis	Screen
Connector body to chassis earth, output cable screen can be connected if required.	

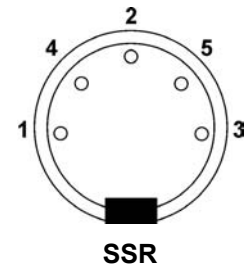

- \* TTL and OCT outputs should be taken from pins 1 or 3 with reference to 0 Volts (pin 2).  
SSR output is between pins 1 and 3 and these outputs are isolated from 0 V.

### 30.6.5 Head input

The head input connectors on the ACC2 and ACC2-2 controllers are 7-pin DIN-type sockets.

Signal descriptions and pin numbers are shown below.

Pin number	Description
1	LED cathode
2	Screen
3	LED anode
4	Probe return (0 V)
5	Probe signal (high)
6	Inhibit return (0 V)
7	Inhibit signal (high)

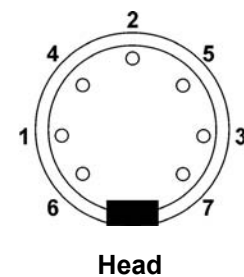

### 30.6.6 RS232 communications

The RS232 communications connectors on the ACC2 and ACC2-2 controllers are 25-pin D-type plugs. Signal descriptions and pin numbers are shown below:

Pin number	Description
1	0 V screen
2	TXD transmit data
3	RXD receive data
4	RTS request to send
5	CTS clear to send, connect pin 4 to pin 5 if CTS is not output from CMM
7	0 V signal ground (common)
20	DTR data terminal ready

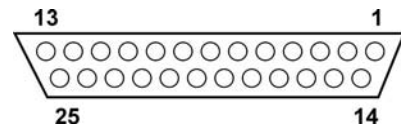

RS232

### 30.6.7 IEEE communications

The IEEE communications connectors on the ACC2 and ACC2-2 controllers are parallel 24-pin D-type sockets. Signal descriptions and pin numbers are shown below:

Pin number	Description	Pin number	Description
1	DI01	13	DI05
2	DI02	14	DI06
3	DI03	15	DI07
4	DI04	16	DI08
5	EOI (24)	17	REN (24)
6	DAV	18	GND (6)
7	NRFD	19	GND (7)
8	NDAC	20	GND (8)
9	IFC	21	GND (9)
10	SRQ	22	GND (10)
11	ATN	23	GND (11)
12	SHIELD	24	GND LOGIC

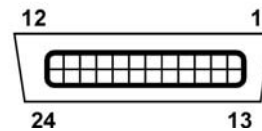

IEEE-488

**NOTE:** GND(n) refers to the signal ground return of the reference contact. EOI and REN return on contact 24.

**Renishaw plc**  
New Mills, Wotton-under-Edge,  
Gloucestershire, GL12 8JR  
United Kingdom

**T** +44 (0)1453 524524  
**F** +44 (0)1453 524901  
**E** uk@renishaw.com  
[www.renishaw.com](http://www.renishaw.com)

**RENISHAW**   
**apply innovation™**

**For worldwide contact details,  
please visit our main website at  
[www.renishaw.com/contact](http://www.renishaw.com/contact)**



H - 1000 - 4068 - 01